

ALTAIR

Altair[®] FluxMotor[®] 2023

Induction machines – Squirrel cage - Inner & Outer rotor

Motor Factory – Test - Characterization

General user information

Contents

1	CHARACTERIZATION – MODEL – MOTOR – BASIC	6
1.1	Overview	6
1.1.1	Positioning and objective	6
1.1.2	User inputs	7
1.1.3	Main outputs	7
1.1.3.1	Table or results	7
1.1.3.2	Curves	7
1.2	Settings	7
1.3	Inputs	8
1.3.1	Introduction	8
1.3.2	Standard inputs	8
1.3.2.1	Line-Line voltage, rms	8
1.3.2.2	Power supply frequency	8
1.3.2.3	Model refinement	8
1.3.2.4	X-Factors	9
1.3.2.5	Model evaluation	9
1.3.2.6	Operating Line-Line voltage	9
1.3.2.7	Operating power supply frequency	9
1.3.3	Advanced inputs	10
1.3.3.1	Model computation mode	10
1.3.3.2	Locked rotor line current, rms	10
1.3.3.3	Locked rotor slip for computation the reduced power supply frequency	10
1.3.3.4	Slip distribution mode	10
1.3.3.5	Number of Finite Element computations	12
1.3.3.6	Slip table	12
1.3.3.7	Skew model – Number of layers	12
1.3.3.8	Rotor initial position	12
1.3.3.9	Mesh order	12
1.3.3.10	Airgap mesh coefficient	12
1.4	Main principles of computation	13
1.4.1	Introduction	13
1.4.2	Electrical equivalent scheme with leakage inductance totaled in rotor	13
1.4.3	Model parameters	13
1.4.3.1	Equivalent scheme coefficients	13
1.4.3.2	Transformation ratio and equivalent scheme coefficient	14
1.4.3.3	Rotor equivalent phase current bring back to the stator and reduced at the stator frequency	14
1.4.3.4	Magnetizing inductance	14
1.4.3.5	Iron loss resistance	14
1.4.3.6	Leakage inductance totaled in rotor	14
1.4.3.7	Rotor equivalent phase resistance brings back to the stator	15
1.4.4	Computations for model identification	16
1.4.4.1	No load computation	16
1.4.4.2	Locked rotor computation	17
1.4.5	Model refinement	19
1.4.6	Model evaluation	19
1.5	Test results	20
1.5.1	Test conditions	20
1.5.1.1	Inputs	20
1.5.1.2	Settings	20
1.5.1.3	Winding and squirrel cage characteristics	20
1.5.1.4	Inter bar resistance and inductance	20

1.5.2	Main results-----	21
1.5.2.1	Machine performance -----	21
1.5.3	Curves -----	21
2	CHARACTERIZATION – MODEL – MOTOR – SSFR-----	22
2.1	Overview-----	22
2.1.1	Positioning and objective -----	22
2.1.2	User inputs -----	23
2.1.3	Main outputs -----	23
2.1.3.1	Table or results-----	23
2.1.3.2	Curves -----	23
2.2	Settings -----	23
2.3	Inputs-----	24
2.3.1	Introduction-----	24
2.3.2	Standard inputs -----	24
2.3.2.1	Operational inductance order -----	24
2.3.2.2	Evaluation of the SSFR model -----	24
2.3.2.3	Operating Line-Line voltage, rms -----	24
2.3.2.4	Operating power supply frequency -----	24
2.3.2.5	Additional moment of inertia -----	24
2.3.2.6	Max. evaluation duration -----	24
2.3.3	Advanced inputs -----	25
2.3.3.1	Linear permeability distribution -----	25
2.3.3.2	Stator permeability -----	25
2.3.3.3	Rotor permeability -----	25
2.3.3.4	Shaft permeability-----	25
2.3.3.5	Working point characteristics -----	25
2.3.3.6	Number of computations per electrical period -----	25
2.3.3.7	SSFR voltage -----	26
2.3.3.8	Skew model – Number of layers -----	26
2.3.3.9	Airgap mesh coefficient-----	26
2.4	Main principles of computation -----	27
2.4.1	Introduction-----	27
2.4.2	Model representation -----	27
2.4.2.1	Second order model -----	27
2.4.2.2	First order model -----	28
2.4.3	Test procedure -----	29
2.4.3.1	Short description -----	29
2.4.3.2	Additional information -----	31
2.4.3.3	Model evaluation -----	32
2.5	Test results-----	33
2.5.1	Test conditions -----	33
2.5.1.1	Inputs -----	33
2.5.1.2	Settings -----	33
2.5.1.3	Winding and squirrel cage characteristics -----	33
2.5.1.4	Inter bar resistance and inductance -----	33
2.5.2	Main results-----	33
2.5.2.1	Operational inductance -----	33
2.5.2.2	Equivalent circuit -----	33
2.5.2.3	Model evaluation -----	33
3	CHARACTERIZATION – MODEL – MOTOR – SCALAR-----	34
3.1	Overview-----	34

3.1.1	Positioning and objective	34
3.1.2	User inputs	35
3.1.3	Main outputs	35
3.2	Settings	35
3.3	Inputs	36
3.3.1	Introduction	36
3.3.2	Standard inputs	36
3.3.2.1	Maximum Line-Line voltage, rms	36
3.3.2.2	Rated power supply frequency	36
3.3.2.3	Maximum speed	36
3.3.3	Advanced inputs	36
3.3.3.1	Electrical equivalent scheme identification	36
3.3.3.2	Model maps identification - Number of computations for Line-Line voltage	36
3.3.3.3	Model maps identification - Number of computations for power supply frequency	36
3.3.3.4	Operation of the non-linear model to generate T(U,f,s)	36
3.3.3.5	Operation of model to generate T(U,f,s) - Number of computations for Line-Line voltage	37
3.3.3.6	Operation of model to generate T(U,f,s) - Number of computations for power supply frequency	37
3.3.3.7	Operation of model to generate T(U,f,s) – Slip distribution mode	37
3.3.3.8	Operation of model to generate T(U,f,s) – Slip table	38
3.3.3.9	Skew model – No. of layers	39
3.3.3.10	Rotor initial position	39
3.3.3.11	Airgap mesh coefficient	39
3.4	Main principles of computation	40
3.5	Test results	40
3.5.1	Test conditions	40
3.5.1.1	Inputs	40
3.5.1.2	Settings	40
3.5.1.3	Winding and squirrel cage characteristics	40
3.5.1.4	Inter bar resistance versus rotor frequency over the operating range	40
3.5.1.5	Inter bar inductance versus rotor frequency over the operating range	40
3.5.2	Main results	41
3.5.2.1	Machine performance – Starting torque	41
3.5.2.2	Power electronics	41
3.5.3	Curves	41
3.5.4	Characteristics curves	41
4	Characterization – Thermal – Motor & Generator – Steady state	42
4.1	Overview	42
4.1.1	Positioning and objective	42
4.1.2	User inputs	42
4.1.3	Main outputs	42
4.2	Settings	43
4.3	Inputs	43
4.3.1	Introduction	43
4.3.2	Standard inputs	43
4.3.2.1	Speed	43
4.3.2.2	Set of losses	43
4.3.2.3	Input import	43
4.3.3	Advanced input	44
4.4	Main principles of computation	45
4.4.1	Introduction	45

4.4.2	Flow chart	46
4.5	Test results	47
4.5.1	Test conditions	47
4.5.1.1	Inputs	47
4.5.1.2	Settings	47
4.5.2	Main results	47
4.5.2.1	Main thermal parameters	47
4.5.3	Limitation of thermal computations – Advice for use	48
5	Characterization – Thermal – Motor & Generator – Transient	49
5.1	Overview	49
5.1.1	Positioning and objective	49
5.1.2	User inputs	49
5.1.3	Main outputs	49
5.2	Settings	50
5.3	Inputs	50
5.3.1	Introduction	50
5.3.2	Standard inputs	50
5.3.2.1	Speed	50
5.3.2.2	Set of losses	50
5.3.2.3	Time definition	50
5.3.2.4	Input import	51
5.3.3	Advanced input	51
5.4	Main principles of computation	52
5.4.1	Introduction	52
5.4.2	Flow chart	53
5.5	Test results	54
5.5.1	Test conditions	54
5.5.1.1	Inputs	54
5.5.1.2	Settings	54
5.5.2	Main results	54
5.5.3	Presentation of temperature charts	54
5.6	Limitation of computations - Advice for use	54

1 CHARACTERIZATION – MODEL – MOTOR – BASIC

1.1 Overview

1.1.1 Positioning and objective

The aim of the test “Characterization – Model – Motor – Basic” is to identify the parameters of an electrical equivalent scheme of the 3-Phase induction machine with squirrel cage according to targeted input values U and f (Magnitude of line-line voltage and Power supply frequency).

This test can be described into three main steps:

- First, the equivalent scheme called “Original Model” is characterized by performing the two following classical tests: The No-load test and the locked-rotor test.
- Then, it is possible to improve the accuracy of the “Original model” by using refinement process to obtain a “Refined Model”.
- And lastly, once the model identification is done, it is possible to evaluate machine behavior by considering various working point defined by the magnitude of “Operating line-line voltage” and “Operating power supply frequency”.

Note: At any time, the relevance of the model parameters can be checked by comparing the results got with this model and those got with the Finite Element computations.

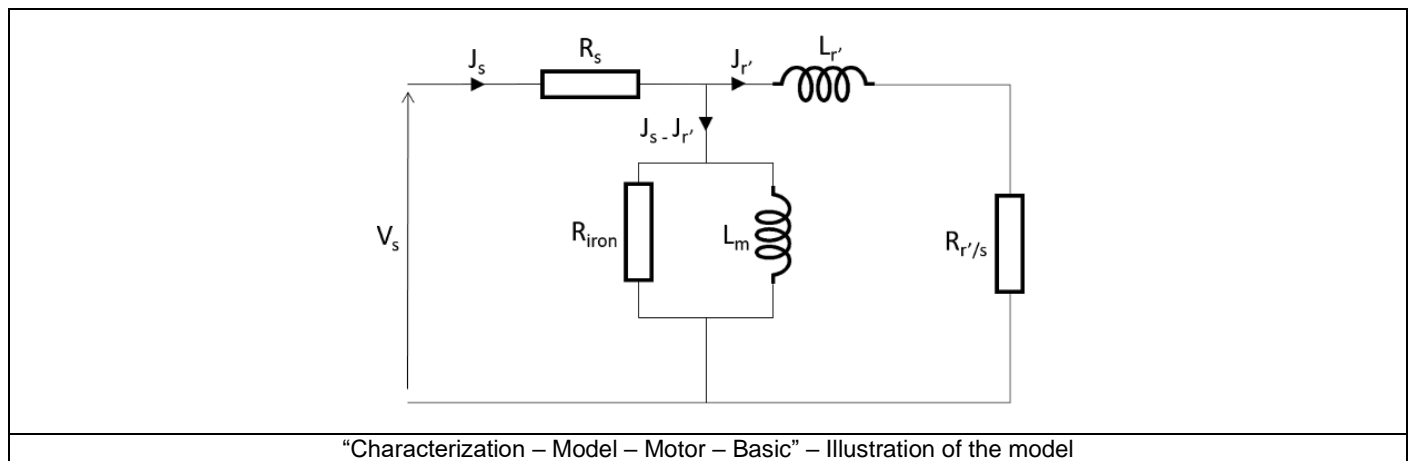

Warnings! The resulting model is a linear one, so it cannot provide accurate results on the whole ranges of operating voltages and frequencies.

To get a good accuracy of results, it is highly recommended to use the model with a Line-Line voltage and even more a Power supply frequency close to those used for its identification.

Based on the resulting electrical equivalent scheme, results are computed and displayed to give an overview of the electromagnetic analysis of the machine. General data of the machine, like mechanical torque, currents, power factor and power balance are computed and displayed as curves.

System integrators and / or control-command engineers will find a tool adapted to their needs. Indeed, the resulting equivalent scheme can be used into a system simulation software for evaluating the interaction between the machine and the system in which it is integrated. The following table helps to classify the test “Characterization – Model – Motor – Basic”.

Family	Characterization
Package	Model
Convention	Motor
Test	Basic

Positioning of the test “Characterization – Model – Motor – Basic”

1.1.2 User inputs

The main user input parameters are the Line-Line voltage and the power supply frequency. Then, other inputs allow to refine and to evaluate the resulting model.
In addition, temperatures of winding and squirrel cage must be set.

1.1.3 Main outputs

Test results are illustrated with data, graphs, and tables

For the model identification, as well as for the model evaluation the same results are computed and displayed:

1.1.3.1 Table of results

- 1) Equivalent scheme parameters
 - Parameters
- 2) Machine performance – No load
 - General data
 - Machine constants
 - Power balance
- 3) Machine performance – Locked-rotor
 - General data
 - Machine constants
 - Power balance
- 4) Machine performance - Various working points (Breakdown torque, motor starting torque)
 - General data
 - Machine constants
 - Power balance

1.1.3.2 Curves

- 1) Mechanical torque versus slip
- 2) Stator current versus slip
- 3) Efficiency versus slip
- 4) Power factor versus slip
- 5) Power balance versus slip
- 6) Losses versus slip
- 7) Iron losses versus slip
- 8) Joule losses versus slip
- 9) Current density versus slip

1.2 Settings

Two buttons give access to the following setting definition:

- Temperature of active components: winding and squirrel cage
- Definition of mechanical loss model parameters (for computing the power balance)

For more details, please refer to the document: [MotorFactory_2023_IMSQ_IOR_3PH_Test_Introduction](#) .

1.3 Inputs

1.3.1 Introduction

The total number of user inputs is equal to 16.
Among these inputs, 7 are standard inputs and 9 are advanced inputs.

1.3.2 Standard inputs

1.3.2.1 Line-Line voltage, rms

The rms value of the Line-Line voltage supplying the machine: **"Line-Line voltage, rms"** (*Line-Line voltage, rms value*) must be provided.
Note: The number of parallel paths and the winding connection are automatically considered in the results.

1.3.2.2 Power supply frequency

The value of the power supply frequency of the machine: **"Power supply frequency"** (*Power supply frequency*) must be provided.
The power supply frequency is the electrical frequency applied at the terminals of the machine.

1.3.2.3 Model refinement

A refinement of the initial model can be performed. The user's input **"Model refinement"** (*Refinement to improve the original model*) gives three possibilities to the user:

- 1) Model refinement = None

No refinement will be performed.

- 2) Model refinement = Fitting

This choice gives to the user the capability to refine parameters of the equivalent scheme automatically for improving the results.

Note: The criteria for adjusting the parameters is to minimize the difference between results got with the model and those got with Finite Element computation. The three reference quantities for comparing results are the mechanical torque, the stator current and the reactive power.

- 3) Model refinement = X-Factor

When "X-Factor" is selected, a list of X-Factors to be applied to each parameter of the equivalent scheme must be defined by using the next field: "X-Factors to be applied" and by clicking on the button "Set values".

The second one, **"X-Factor"** (*X-Factor*) gives to the user the capability to adjust the parameter of the equivalent scheme manually. The manual adjustment is made thanks to X-Factor parameters which must be filled in the field **"X-Factor"**.

Model refinement = X-Factor	
1	Select the "X-Factor" option.
2	Click the button "Set values" in the field "X-Factors to be applied" to open a dialog box to define the X-Factors to be applied on each parameter of the equivalent scheme.
3	Button to validate and consider the user inputs
4	Button to run the computation

1.3.2.4 X-Factors

When “**Model refinement**” (*Refinements to improve the original model*) is set to “**X-Factor**” (*X-Factor*), “**X-Factors**” must be provided (*X-Factors applied on electrical components*). When the user clicks on “**Set values**” a dialog box appears allowing the user to set X-Factors values.

There are four X-Factors, “Magnetizing inductance factor”, “Iron loss resistance factor”, “Leakage inductance factor” and “Rotor Joule loss resistance factor”.

1.3.2.5 Model evaluation

An evaluation of the original model can be performed. The user’s input “**Model evaluation**” (*Model evaluation for a new set of voltage and frequency*) gives two possibilities to the user:

1) Model evaluation = Yes

The evaluation of the model accuracy is performed with the current model which has been characterized in the previous steps. Based on the model, quantities like mechanical torque, stator current, power factor... are computed and displayed.

2) Model evaluation = Yes /w FE

When “**Yes W/ FE**” (Yes with finite element comparison) is selected, the evaluation of the model accuracy is performed with the current model which has been characterized in the previous steps. However, quantities like mechanical torque, stator current, power factor... are computed, displayed and compared to results obtained with the Finite Element computations.

1.3.2.6 Operating Line-Line voltage

The rms value of the operating Line-Line voltage “**Op. Line-Line voltage, rms**” (*Operating Line-Line voltage to evaluate the equivalent scheme, rms value*) must be provided.

This value allows to perform additional analysis at the targeted voltage.

Note: The number of parallel paths and the winding connection are automatically considered in the results.

1.3.2.7 Operating power supply frequency

The value of the operating power supply frequency “**Op. power supply freq.**” (*Operating power supply frequency to evaluate the equivalent scheme*) must be provided.

This value allows to perform additional analysis at the targeted frequency.

1.3.3 Advanced inputs

1.3.3.1 Model computation mode

There are 2 ways to identify the linear model of the induction machine.

An automatic process can be applied to determine automatically the two needed parameters to perform the test: “Locked rotor line current” and “Locked rotor slip”

In this case, the model computation mode should be “**Auto.**” (*Automatic*)

A user process where the user must provide his own values for the two parameters “Locked rotor line current” and “Locked rotor slip”.

In this case, the model computation mode should be “**User**” (*User*).

1.3.3.2 Locked rotor line current, rms

When the choice of model computation mode is “User”, the rms value of the line current supplying the machine during the locked rotor test “**Lock rotor line current, rms**” (*Locked rotor line current, rms value required for the lock rotor computation*) must be provided. This value allows to identify the model at a targeted point.

1.3.3.3 Locked rotor slip for computation the reduced power supply frequency

If the advance parameter “**Model computation mode**” is set to “User”, the value of slip needed to compute the reduce power supply frequency during the locked rotor test “**Lock rotor slip**” (*Slip value needed to compute the reduced power supply frequency required for the lock rotor computation*) must be provided. This value allows to identify the model at a targeted point.

1.3.3.4 Slip distribution mode

The computation of the test is performed by considering a distribution of computed points. The user’s input “**Slip distribution mode**” (*Select the method for the distribution of computed points*) gives three possibilities to the user:

1) Slip distribution mode = Logarithmic

When “Logarithmic” is selected, the distribution of the computed points is automatically done. The number of computations to be done in the slip range must be set in the next field: “No. comp. in slip range”.

2) Slip distribution mode = Linear

When “Linear” is selected, the distribution of the computed points is automatically done. The number of computations to be done in the slip range must be set in the next field: “No. comp. in slip range”.

3) Slip distribution mode = Table

When “Table” is selected, the list of slips to be considered must be defined by using the next field: “Slip table” and by clicking on the button “Set values”.

Two ways are possible to fill the table: either filling the table line by line or by importing an excel file where all the slips to be considered are defined.

Note: The slips must be listed in ascending order.

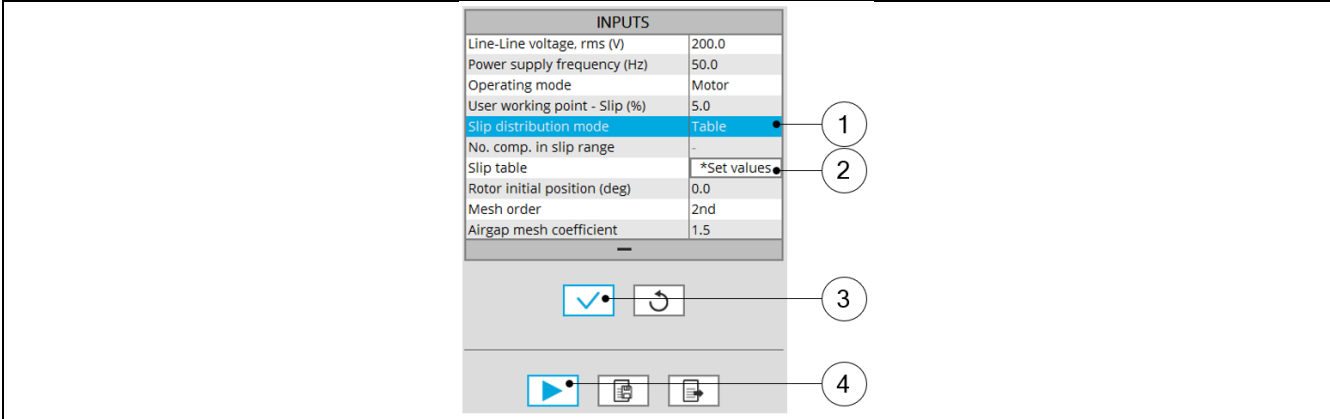

Slip distribution mode = Table	
1	Select the “Table” option.
2	Click the button “Set values” in the field “Slip table” to open a dialog box to define the list of slips to be considered. Refer to the next illustration which shows how to fill the Slip table.
3	Button to validate and consider the user inputs
4	Button to run the computation

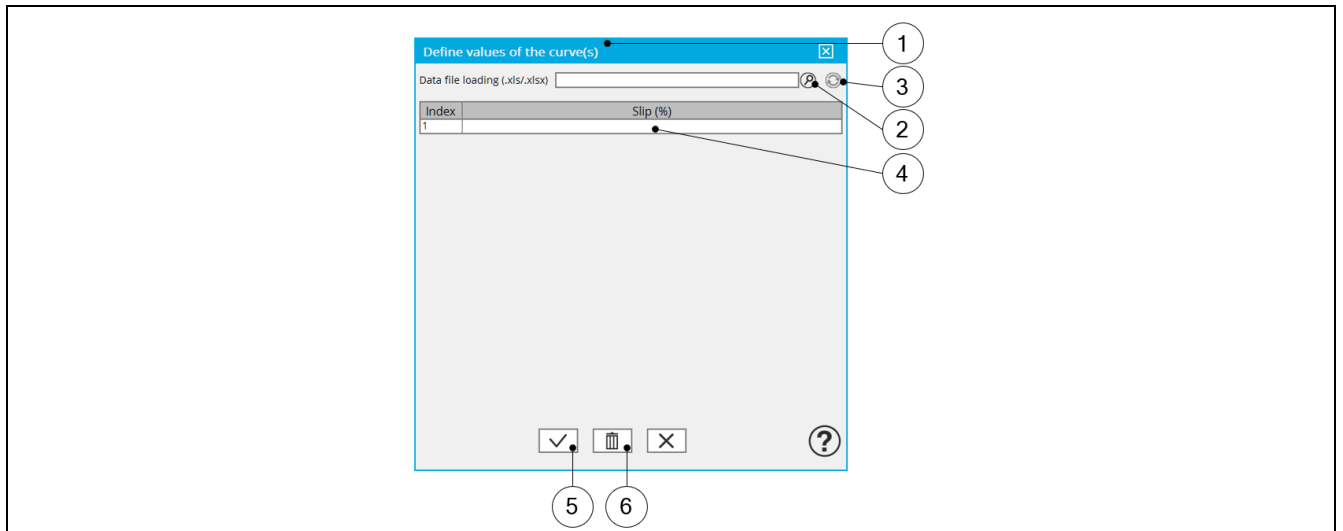

Slip distribution mode = Table – Dialog box to define the list of slips

1	Dialog box opened after clicked on the button “Set values” in the field “Slip table”
2	Browse the folder to select an Excel file which is defined the list of slips
3	Button to refresh the table data when the considered Excel file has been modified
4	Fields to be filled with data to describe the slips to be considered
5	Button to apply the inputs
6	Button to erase the data table

Excel template used to import a list of slips is stored in the folder Resource/Template in the installation folder of FluxMotor®. An example of this template is displayed below.

Slip table	
Label	Slip
Units	%
Values	2
	5
	10
	20

Excel file template to define the list of slips

Note: The slips must be listed in ascending order.

1.3.3.5 Number of Finite Element computations

To compute the T(Slip) curve using Finite Element, the user input “**No. FE computations**” (*Number of Finite Element computations*) must be provided.

This input is required in the internal processes when the following modes are used:

- “Model computation mode” - “Auto.”
- “Refinement for original model” - “Fitting”
- “Model evaluation” – “Yes W. FE”

“**No. FE computations**” influences the accuracy of results and the computation time.

The default value is equal to 15. This value provides a good compromise between the accuracy of results and computation time.

1.3.3.6 Slip table

When the choice of point distribution mode is “**Table**”, the list of slips to be considered must be provided. Refer to the above section 3) Slip distribution mode = Table.

1.3.3.7 Skew model – Number of layers

When the rotor bars or the stator slots are skewed, the number of layers used in Flux® Skew environment to model the machine can be modified: “**Skew model - No. of layers**” (*Number of layers for modelling the skewing in Flux® Skew environment*).

1.3.3.8 Rotor initial position

The initial position of the rotor considered for computation can be set by the user in the field « **Rotor initial position** » (*Rotor initial position*). The default value is equal to 0.

The range of possible values is [-360, 360].

The rotor initial position has an impact only on the induction curve in the air gap.

1.3.3.9 Mesh order

To get the results, the original computation is performed by using a Finite Element Modeling. The geometry of the machine is automatically meshed.

Two levels of meshing can be considered for this finite element calculation: first order and second order.

This parameter influences the accuracy of results and the computation time.

By default, second order mesh is used.

1.3.3.10 Airgap mesh coefficient

The advanced user input “**Airgap mesh coefficient**” is a coefficient which adjusts the size of mesh elements inside the airgap. When the value of “**Airgap mesh coefficient**” decreases, the mesh elements get smaller, leading to a higher mesh density inside the airgap, increasing the computation accuracy.

The imposed Mesh Point (size of mesh elements touching points of the geometry), inside the Flux® software, is described as:

$$\text{MeshPoint} = (\text{airgap}) \times (\text{airgap mesh coefficient})$$

Airgap mesh coefficient is set to 1.5 by default.

The variation range of values for this parameter is [0.05; 2].

0.05 giving a very high mesh density and 2 giving a very coarse mesh density.

Caution:

Be aware, a very high mesh density does not always mean a better result quality. However, this always leads to a huge number of nodes in the corresponding finite element model. So, it means a need of huge numerical memory and increases the computation time considerably.

1.4 Main principles of computation

1.4.1 Introduction

As said previously, the aim of the test “Characterization – Model – Motor – Linear” is to identify the parameters of an electrical equivalent scheme of the 3-Phase induction machine with squirrel cage according to targeted input values U and f (Magnitude of line-line voltage and Power supply frequency).

The “Original model” used is based on a classical equivalent scheme with leakage inductance totaled in rotor. The identification of the model is performed considering the two following classical tests: The No-load test and the locked-rotor test. The corresponding computations are performed with a Finite Element modelling using a Steady State AC application.

Then, the accuracy improvement of the original model can be operate using refinement processes like a “Fitting” or “X-Factor” to obtain a “Refined Model”.

Lastly, once the equivalent model is available, it is possible to evaluate its behavior by considering various working point defined by the magnitude of “Operating line-line voltage” and “Operating power supply frequency”.

1.4.2 Electrical equivalent scheme with leakage inductance totaled in rotor

We have chosen to identify the electrical equivalent scheme with totalized leakage inductance at the rotor. Because it’s one of the easiest to use and to apply a “V/f scalar control command”.

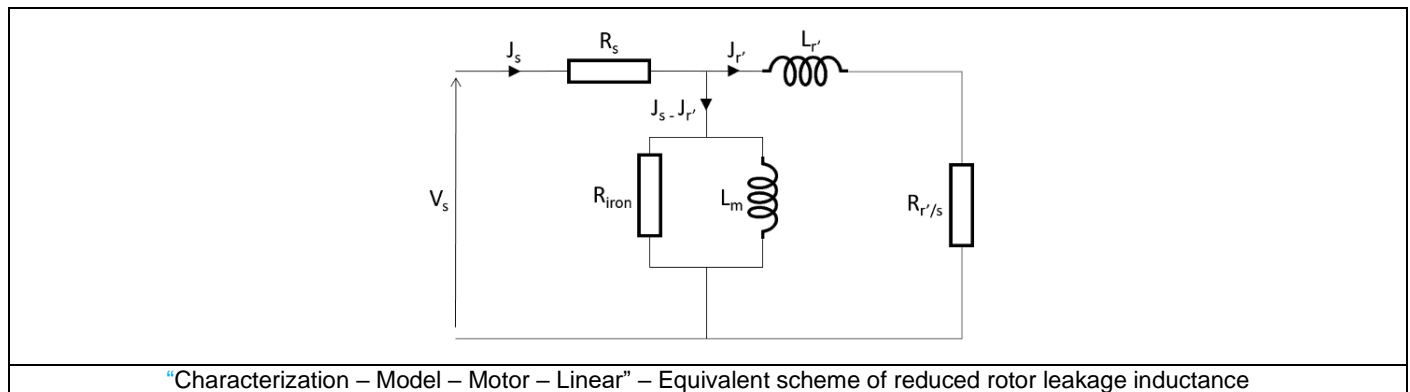

V_s : Stator phase voltage at the frequency “ f_s ”

J_s : Stator phase current at the frequency “ f_s ”

R_s : Stator phase resistance

L_m : Magnetizing inductance

R_{iron} : Iron losses resistance (stator and rotor)

J_r' : Rotor equivalent phase current bring back to the stator and reduced at the stator frequency “ f_s ”

L_r' : Leakage inductance totaled in rotor

R_r/s : Rotor equivalent phase resistance brings back to the stator

All the equivalent scheme parameters are defined in the following subsection. Then, the computations carried out to identify the model are presented with the no-load and the locked-rotor computations.

1.4.3 Model parameters

1.4.3.1 Equivalent scheme coefficients

An equivalent scheme corresponds to a specific value of the coefficient “ m ”. There are as many equivalent schemes as there are coefficient values “ m ”. This equivalent scheme above is characterized by a coefficient “ m ” defined such as:

$m = \frac{L_s}{\frac{3}{2} \times M_{rs}}$	$L_s = l_s - m_s$
---	-------------------

L_s : Stator cyclic inductance (Cyclic means that the contribution of the 3 phases is considered)

l_s : Stator self-inductance

m_s : Stator mutual inductance (between 2 stator phases)

M_{rs} : Mutual inductance magnitude between a stator phase and a rotor phase (when the position of the rotor corresponds to a stator phase opposite a rotor phase)

1.4.3.2 Transformation ratio and equivalent scheme coefficient

When we make the analogy with a wound rotor, the transformation ratio is defined such as:

$$\frac{V_1^0}{V_s^0} = \frac{\frac{3}{2} \times M_{rs}}{L_s} = \frac{1}{m}$$

V_1^0 : No-load rotor phase voltage

V_s^0 : No-load stator phase voltage

L_s : Stator cyclic inductance (Cyclic means that the contribution of the 3 phases is considered)

M_{rs} : Mutual inductance magnitude between a stator phase and a rotor phase (when the position of the rotor corresponds to a stator phase opposite a rotor phase)

m : Equivalent scheme coefficient

The transformation ratio " $\frac{V_1^0}{V_s^0}$ " is the inverse of the equivalent scheme coefficient " m ".

1.4.3.3 Rotor equivalent phase current bring back to the stator and reduced at the stator frequency

The rotor equivalent phase current " J_r' " brings back to the stator and reduced at the stator frequency " f_s " is defined such as:

$J_r' = -\frac{J_r}{m}$	$J_r' = -J_r \times \frac{\frac{3}{2} \times M_{rs}}{L_s}$
-------------------------	--

J_r : Rotor equivalent phase current at the frequency " $g \times f_s$ "

J_r' : Rotor equivalent phase current bring back to the stator and reduced at the stator frequency " f_s "

m : Equivalent scheme coefficient

1.4.3.4 Magnetizing inductance

The magnetizing inductance is defined such as:

$L_m = m \times \frac{3}{2} \times M_{rs}$	$L_m = L_s$
--	-------------

1.4.3.5 Iron loss resistance

The iron loss resistance " R_{iron} " is added to the equivalent scheme in parallel with of the magnetizing inductance to be able to consider the stator and rotor iron losses in the power balance during the solving of the circuit.

1.4.3.6 Leakage inductance totaled in rotor

The total leakage inductance totalized to the rotor " L_r' " is defined such as:

$L_r' = m^2 \times \sigma \times L_r = m^2 \times N_r$	$L_r' = \left(\frac{L_s}{\frac{3}{2} \times M_{rs}} \right)^2 \times \sigma \times L_r = \left(\frac{L_s}{\frac{3}{2} \times M_{rs}} \right)^2 \times N_r$
--	--

L_r : Rotor cyclic inductance (Cyclic means that the contribution of the 3 phases is considered, which is a vision of the mind in the case of a squirrel cage machine)

σ : Blondel leakage coefficient

N_r : Boucherot's total leakage inductance

Boucherot's total leakage inductance " N_r " is defined such as:

$$N_r = \sigma \times L_r$$

Blondel leakage coefficient " σ " is defined such as:

$$\sigma = 1 - \frac{\left(\frac{3}{2} \times M_{rs}\right)^2}{L_s \times L_r}$$

L_r : Rotor cyclic inductance (Cyclic means that the contribution of the 3 phases is considered, which is a vision of the mind in the case of a squirrel cage machine)

L_s : Stator cyclic inductance (Cyclic means that the contribution of the 3 phases is considered)

M_{rs} : Mutual inductance magnitude between a stator phase and a rotor phase (when the position of the rotor corresponds to a stator phase opposite a rotor phase)

Note, for a perfect electromagnetic coupling, we have " $\left(\frac{3}{2} \times M_{rs}\right)^2 = L_s \times L_r$ " so " $\sigma = 0$ " which means no flux leakage between stator and rotor. Commonly the order of magnitude is " $\sigma < 10\%$ "

1.4.3.7 Rotor equivalent phase resistance brings back to the stator

The rotor equivalent phase resistance " R'_r " brings back to the stator is defined such as:

$R'_r = m^2 \times R_r$	$R'_r = \left(\frac{L_s}{\frac{3}{2} \times M_{rs}}\right)^2 \times R_r$
-------------------------	--

J_r : Rotor equivalent phase current at the frequency " $s \times f_s$ "

J'_r : Rotor equivalent phase current bring back to the stator and reduced at the stator frequency " f_s "

m : Equivalent scheme coefficient

The resistance " R'_r " is not the rotor phase resistance. However, rotor Joule losses stay equivalent:

$$R'_r \times J_r'^2 = m^2 \times R_r \times \left(-\frac{J_r}{m}\right)^2 = R_r \times (J_r)^2$$

" $R'_r \times J_r'^2$ " is representative of rotor Joule losses.

" $\frac{(1-s)}{s} \times R'_r \times J_r'^2$ " is representative of electromagnetic torque.

1.4.4 Computations for model identification

1.4.4.1 No load computation

The no load computation is done for a very small value of slip “0.1 %” to be close to the synchronous speed at the rated voltage and the rated power supply frequency.

The equivalent scheme corresponding to the no-load computation is shown in the following picture.

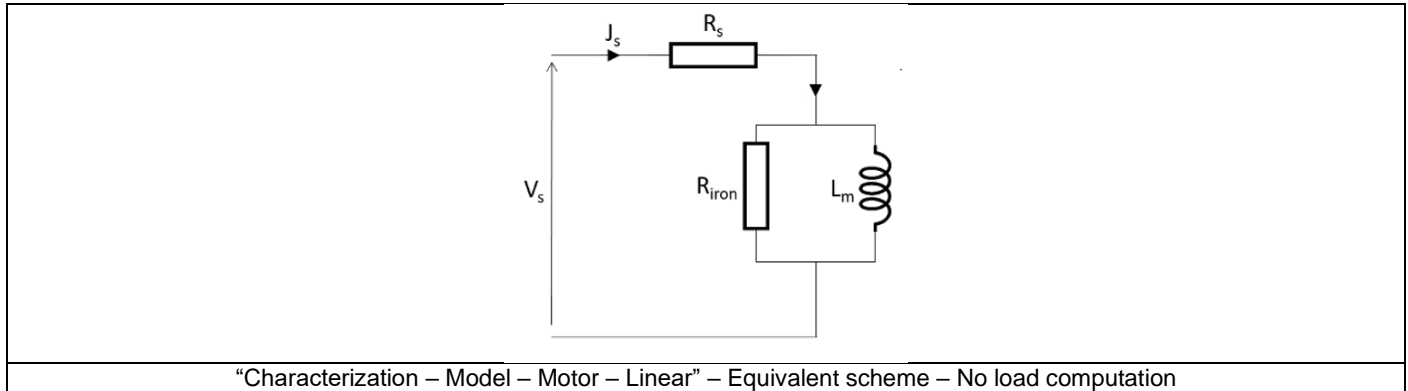

“ R_{iron} ” and “ L_m ” are deduced from computation results according to the following equations:

$$L_m = \frac{1}{2 \times \pi \times f_s} \times \frac{3 \times (\text{abs}(V_{s0} - R_s \cdot J_{s0}))^2}{Q_0}$$

$$X_m = L_m \times 2 \times \pi \times f_s$$

$$R_{iron} = \frac{3 \times (\text{abs}(V_{s0} - R_s \cdot J_{s0}))^2}{W_{iron\ tot.\ 0}}$$

J_{s0} :	Phase current at no load
V_{s0} :	Phase voltage at no load
Q_0 :	Reactive electrical power at no load
f_s :	Power supply frequency
$W_{iron\ tot.\ 0}$:	Total iron losses at no load
L_m :	Magnetizing inductance
X_m :	Magnetizing reactance

Note: Stator leakage inductance is neglected because it is considered small compared with the magnetizing inductance and the stator resistance.

1.4.4.2 Locked rotor computation

The locked rotor computation is done with a slip equal to “100 %” (to be at zero speed) and for the “Locked-rotor line current” and the “Locked rotor slip red. freq.”.

The “Locked rotor slip red. freq.” allows to compute the “Reduced power supply frequency” which corresponds to the power supply frequency of the computation:

$$f_{s \text{ red. freq.}} = S_{\text{red. freq.}} \times f_s$$

f_s :	Power supply frequency
$f_{s \text{ red. freq.}}$:	Reduced power supply frequency
$S_{\text{red. freq.}}$:	Slip to be considered when computing the reduced power supply frequency

When “Model computation mode” is set to “Auto.”, “Locked-rotor line current” and the “Locked-rotor slip red. freq.” are automatically set by an internal process.

In this case, a Steady state AC computation is done over the motor slip range (considering the “Line-Line voltage” and the “Power supply frequency” as inputs).

Then, the “Locked-rotor line current” and the “Locked-rotor slip red. freq.” are got from the values obtained at the maximum torque over the slip range.

When “Model computation mode” is set to “User”, “Locked-rotor line current” and the “Locked-rotor slip red. freq.” must be provided by the user to define the targeted working point for identifying the linear model.

Then, the “Reduce power supply frequency” can be computed.

For the locked-rotor computation, a “Reduce power supply frequency” is used in order to be as close as possible to the real operating conditions and more precisely as close as possible to the rotor real operating conditions (according to the targeted working point for identifying the model).

In order to obtain a linear model with a good accuracy in the T(Slip) curve linear part, it is recommended to use the breakdown torque in motor mode as the targeted working point (automatic methods).

The equivalent scheme corresponding to the no-load computation is shown in the following figure.

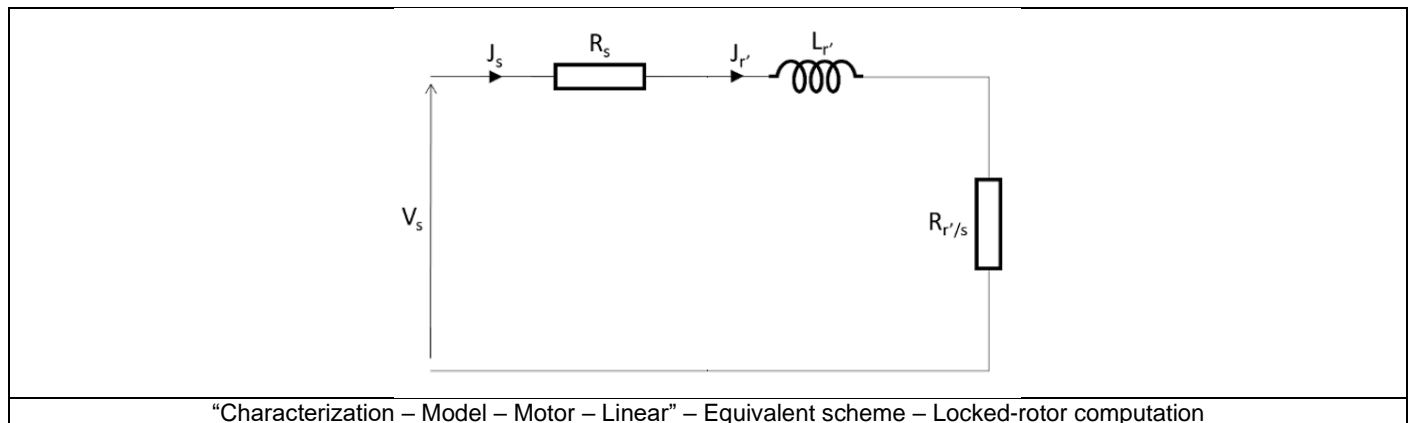

“ R_r' ” and “ N_r ” are deduced from results according to the following equations:

$$N_r = \frac{1}{2 \times \pi \times f_{s \text{ red. freq.}}} \times \frac{3 \times (\text{abs}(V_s - R_s \cdot J_{s \text{ LR}}))^2}{Q_{LR}}$$

$$X_r = N_r \times 2 \times \pi \times f_s$$

$$P_{elec.} = \sqrt{3} \times U_s \times I_{s \text{ LR}} \times PF_{LR}$$

$$W_{Jr \text{ LR}} = S \times (P_{elec. \text{ LR}} - W_{J_s \text{ LR}} - W_{LR \text{ iron stat. LR}}) - W_{LR \text{ iron rot. LR}}$$

$$R_r' = \frac{W_{Jr \text{ LR}}}{3 \times J_{s \text{ LR}}^2}$$

S :	Slip
$J_{s \text{ LR}}$:	Phase current at locked-rotor
$I_{s \text{ LR}}$:	Line current at locked-rotor
V_s :	Phase voltage
U_s :	Line-Line voltage
Q_{LR} :	Reactive electrical power at locked rotor
f_s :	Power supply frequency
$f_{s \text{ red. freq.}}$:	Reduced power supply frequency
$W_{iron \text{ stat. LR}}$:	Stator iron losses at locked rotor
$W_{iron \text{ rot. LR}}$:	Rotor iron losses at locked rotor
PF_{LR} :	Power factor at locked rotor
$W_{Jr \text{ LR}}$:	Rotor Joule losses at locked rotor
$W_{J_s \text{ LR}}$:	Stator Joule losses at locked rotor
N_r :	Leakage inductance totaled in rotor
X_r :	Leakage reactance totaled in rotor
R_r' :	Rotor equivalent phase resistance brings back to the stator

Notes:

The magnetizing current “ $J_s - J_r'$ ” is neglected because it's considered small in front of “ J_r' ” current.

“ L_r' ” is computed at “ $f_{s \text{ red. freq.}}$ ” but “ X_r ” is computed at “ f_s ”

All iron losses are considered to compute “ R_r' ”, so iron losses are considered in the power balance to identify the linear model in the same way for the test “T(Slip)”

1.4.5 Model refinement

Whatever is the chosen model refinement method, Fitting or X-Factor, the principle is the same, X-Factors which are automatically or manually defined are applied to the four equivalent scheme parameters to get new equivalent scheme behavior.

The four considered X-Factors are the following ones:

- $XF_{R_{iron}}$: Magnetizing inductance factor
- XF_{L_m} : Iron losses resistance factor
- XF_{N_r} : Leakage inductance factor
- $XF_{R_{r'}}$: Rotor Joule losses resistance factor

Warning! Increase the accuracy of the model for a set of input data “Line-Line voltage” and “Power supply frequency” does not ensure the model improvement over a full range of operating working points

1.4.6 Model evaluation

The evaluation of the accuracy of the linear model is based on the resulting equivalent scheme with the considered “Op. Line – Line voltage, rms” and “Op. power supply freq.” set by the user.

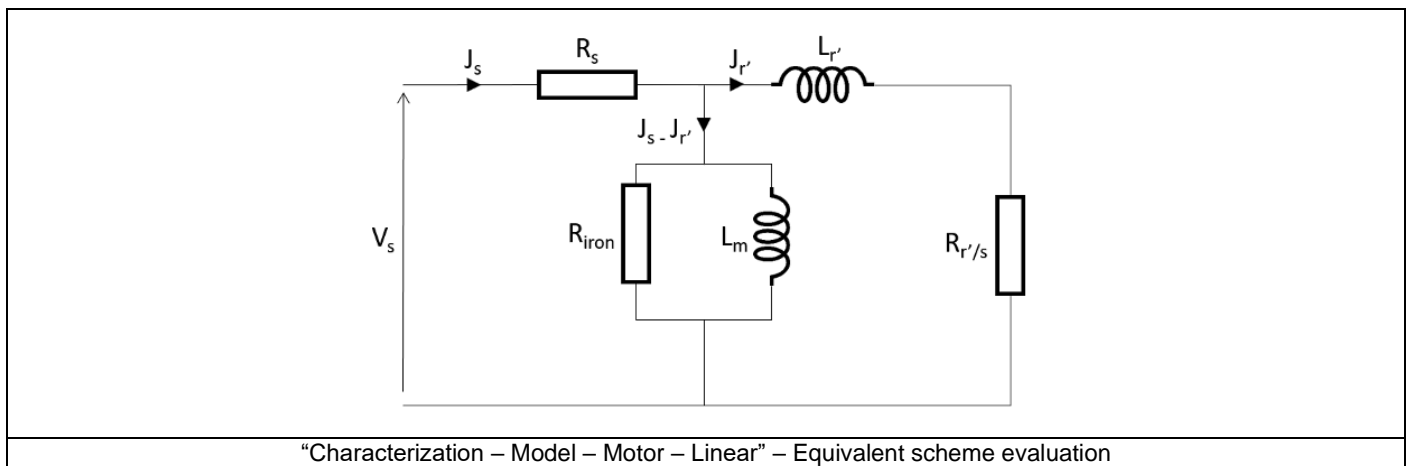

The resulting equivalent scheme corresponds to the original model or the refined one according to whether a refinement has been performed or not.

Note 1: In addition, a Finite Element computation can be done considering the same input data (“Operating Line - Line voltage and the “Operating power supply frequency” to precisely determine the validity range the model.

Note 2: The only operating mode addressed by this test is “Motor”.

In motor mode, the torque is positive « $\Gamma > 0$ » and the speed is positive « $N > 0$ », so, the resulting mechanical power is also positive « $P_{mech.} > 0$ ». As the motor convention is used, the electrical power is regarded to be positive « $P_{elec.} > 0$ ». According to the power flow, the electrical power is greater than the mechanical power « $P_{elec.} > P_{mech.}$ ».

Note 3: The integration of iron losses into the power balance as well as the consideration of mechanical losses can lead to a negative mechanical power. In this case, there are too many losses to provide mechanical power, so, the operating points involved are assumed physically unreachable and therefore not displayed.

1.5 Test results

Once a test is finished, the corresponding results are automatically displayed in the central window.

1.5.1 Test conditions

1.5.1.1 Inputs

All the parameter values, belonging to standard inputs or advanced inputs are described in this section. It shows the initial conditions considered for the test.

Here are the displayed subsections:

- Context
- Standard parameters
- Advanced parameters

For more details, please refer to the document: [MotorFactory_2023_IMSQ_IOR_3PH_Test_Introduction](#) .

1.5.1.2 Settings

All the settings dedicated to the test and dealing with the thermal are displayed in this section.

Here is the displayed subsection:

- Thermal
- Mechanics

1.5.1.3 Winding and squirrel cage characteristics

The winding and squirrel cage characteristics are displayed in the following subsections:

- Winding characteristics
- Squirrel cage characteristics

1.5.1.4 Inter bar resistance and inductance

Two curves representing the resistance and inductance versus frequency and considering the temperature of the squirrel cage components set by the user are displayed.

1.5.2 Main results

1.5.2.1 Machine performance

Whatever is the considered working point (Starting torque, break down torque - Motor mode, break down torque - Generator mode, Minimum breaking torque or User working point) the output data is displayed

Here are the displayed subsections:

- General data
- Machine constants
- Power balance
- Flux in airgap
- Flux density in iron

- Working point

The power balance and the corresponding efficiencies are computed and displayed for the machine, the power electronics stage and for the system (i.e. machine + power electronics stage).

For more details, please refer to the document: [MotorFactory_2023_IMSQ_IOR_3PH_Test_Introduction](#) .

1.5.3 Curves

- Mechanical torque versus slip
- Stator current versus slip
- Efficiency versus slip
- Power factor versus slip
- Power balance versus slip
- Losses versus slip
- Iron losses versus slip
- Joule losses versus slip
- Current density versus slip

2 CHARACTERIZATION – MODEL – MOTOR – SSFR

2.1 Overview

2.1.1 Positioning and objective

The aim of the test “**Characterization – Model – Motor – SSFR**” is to characterize all the parameters of the equivalent scheme by performing a frequency analysis.

Then, the resulting equivalent scheme can be evaluated by simulating the starting of the considered induction machine. The speed, torque and absorbed current versus time are computed and displayed.

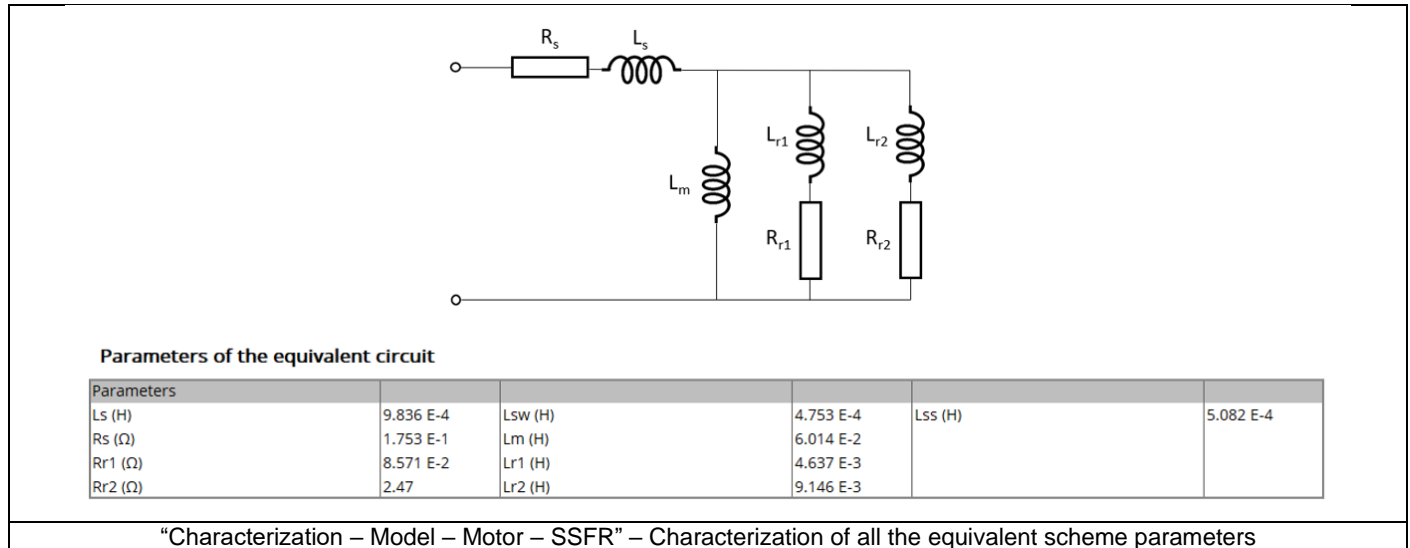

These results are based on the magnitude and the phase of the operational inductance transfer function which are computed with Finite Element software Flux® 2D.

The following table helps to classify the test “Characterization – Model – Motor – SSFR”.

Family	Characterization
Package	Model
Convention	Motor
Test	SSFR

Positioning of the test “Characterization – Model – Motor – SSFR”

2.1.2 User inputs

The main user input parameter is the order of the operational inductance transfer function. 1st and 2nd order are considered depending on the squirrel cage topology but also on the results accuracy got with the 1st order model.

Then, the Line-Line voltage and the power supply frequency must be given to compute instantaneously, the induction motor starting based on the resulting equivalent scheme.

In addition, temperatures of stator winding and squirrel cage must be set.

2.1.3 Main outputs

The main outputs are all the computed parameters of the equivalent scheme (First or second order).

The quality of results is also illustrated with the superimposition of the magnitude and phase of the operational inductance is computed either with Finite Element software Flux® 2D (Steady State AC application) or analytically by considering the resulting operational inductance.

2.1.3.1 Table or results

1) Equivalent scheme parameters

- Operational inductance Laplace function with the corresponding computed parameters
- Induction machine equivalent scheme (first and second order) with its associated computed parameters
- Model evaluation – Start-up characteristics

2.1.3.2 Curves

- 1) Magnitude of the operational inductance versus frequency
- 2) Phase of the operational inductance versus frequency
- 3) Model evaluation – Speed versus time
- 4) Model evaluation – Torque versus time
- 5) Model evaluation – Current versus time

2.2 Settings

One button gives access to the following setting definition:

- Temperature of active components: Stator winding and squirrel cage

For more details, please refer to the document: [MotorFactory_2023_IMSQ_IOR_3PH_Test_Introduction](#).

2.3 Inputs

2.3.1 Introduction

The total number of user inputs is equal to 10.
Among these inputs, 6 are standard inputs and 4 are advanced inputs.

2.3.2 Standard inputs

2.3.2.1 Operational inductance order

The **operational inductance order** (Operational inductance order) can be either “1st” order or “2nd” order. This choice depends on the squirrel cage topology but also on the results obtained with the 1st order model. When the first order model doesn't allow getting good fitting between computation results from Finite Elements computations of the operational inductance and those got with the resulting analytical model, the 2nd order is needed. By default, this input is set to “1st order”.

2.3.2.2 Evaluation of the SSFR model

The “**Model evaluation**” of the resulting equivalent scheme (*Model evaluation of SSFR model by a direct starting test*) is possible by performing a direct starting of the motor.
The starting is operated with a start winding connection.
When the “Model evaluation” is “Yes”, quantities like speed, electromagnetic torque and stator current are computed, and displayed based on the calculated model.
By default, this input is set to “No”.

2.3.2.3 Operating Line-Line voltage, rms

The rms value of the Line-Line voltage supplying the machine: “**Op. Line-Line voltage, rms**” (*Line-Line voltage, rms value*) must be provided to compute the starting of the motor.

Notes:

- The number of parallel paths is automatically considered in the results.
- The starting is always operated by considering a start winding connection.

2.3.2.4 Operating power supply frequency

The value of the power supply frequency of the machine: “**Op. power supply frequency**” (*Operating power supply frequency to evaluate the SSFR model*) must be provided.

The power supply frequency is the electrical frequency applied at the terminals of the machine.

2.3.2.5 Additional moment of inertia

An additional moment of inertia: “**Add. moment of inertia**” (*Additional moment of inertia*) can be added for considering an additional moment of inertia of a load on the shaft line for instance.

By default, this input is equal to 0 N.m.

2.3.2.6 Max. evaluation duration

The **Max. evaluation duration** (*Maximum evaluation duration*) allows to limit the computation time needed to evaluate the starting of the motor.

However, an internal process detects automatically when the motor reaches the steady state after the transient starting phase. When the time required for reaching the steady state is lower than the maximum evaluation duration, the computation ends automatically. When the steady state is established instead of computing the maximum evaluation duration it ends automatically.

By default, this input is equal to 1 second.

2.3.3 Advanced inputs

2.3.3.1 Linear permeability distribution

Two methods allow defining the permeability in the magnetic circuit of the machine; either the magnetic permeability is constant in the stator, rotor and shaft or the magnetic permeability is linked to the magnetic state of the machine when running at a working point.

When the “Linear permeability distribution” mode is “**Constant**”, the relative magnetic permeability must be defined for the stator, the rotor, and the shaft.

When the “Linear permeability distribution” mode is “**Working point**” the characteristics of the working point must be defined with the Line-Line voltage U , the power supply frequency f and the speed N .

Then, the magnetic permeability mapping of a motor is done at the selected working point (U , f , N).

The resulting map of permeability is then applied to the model while performing the frequency analysis. This is what we call the frozen permeability method.

2.3.3.2 Stator permeability

This input allows to set the value of the magnetic permeabilities for the stator. To meet the requirements of the test assumptions, the computations with Finite Elements are operated by considering linear ferromagnetic materials.

The relative permeability of the stator “**Stator permeability**” (*stator magnetic relative permeability*) is by default set to Auto. In this auto mode, the applied stator relative permeability is computed by an internal process (see illustration in below section) in case of a nonlinear magnetic material since the SSFR test is based on the principle that magnetic materials need to be linear.

In case of a linear magnetic material, the stator permeability is the one defined in the material properties (no internal computation is necessary).

The user can enter his own stator permeability by using the toggle button added for this purpose.

This value allows to perform the SSFR test.

2.3.3.3 Rotor permeability

This input allows to set the value of the magnetic permeabilities for the rotor. To meet the requirements of the test assumptions, the computations with Finite Elements are operated by considering linear ferromagnetic materials

The relative permeability of the rotor “**Rotor permeability**” (*rotor magnetic relative permeability*) is defined as the stator permeability by two modes. An auto mode and a user mode. By default, it is set to Auto.

This value allows to perform the SSFR test.

2.3.3.4 Shaft permeability

This input allows to set the value of the magnetic permeabilities for the shaft. To meet the requirements of the test assumptions, the computations with Finite Elements are operated by considering linear ferromagnetic materials

The relative permeability of the shaft “**Shaft permeability**” (*shaft magnetic relative permeability*) is defined as the stator and rotor permeabilities in case of the existence of a shaft. By default, the relative permeability of the shaft is set to Auto.

Note that, if a shaft is added to a motor, the default value of the shaft permeability is equal to the rotor permeability for an IMSQ IR. For an IMSQ OR, it's the same as the stator permeability. To have the real shaft permeability, users need to restore default values of the SSFR test. The user can set his own shaft permeability using the toggle button added for this purpose.

2.3.3.5 Working point characteristics

When the “Linear permeability distribution” mode is “working point, it means that the frequency analysis to compute the operational inductance - $L(p)$ – is based on a working point defined with the Line-Line voltage U , the power supply frequency f , and the speed N .

Hence, these three data must be defined:

- **WP- Line-Line voltage** (*working point – Line-Line voltage, rms value*)
- **WP- power supply frequency** (*working point – power supply frequency*)
- **WP- Slip** (*working point – slip*)

2.3.3.6 Number of computations per electrical period

To get the quantities like the speed, torque and current versus time, an analytical computation is performed

The number of computations per electrical period “**No. comp. / elec. period**” (*Number of computations per electrical period*) influences the accuracy of results and the computation time.

The default value is equal to 50. The minimum allowed value is 40. This default value provides a good compromise between the accuracy of results and computation time.

2.3.3.7 SSFR voltage

The rms value of the SSFR voltage “**SSFR voltage, rms**” (*Voltage between two terminals during SSFR test, rms value*) must be provided. This value allows to perform the SSFR test.

Notes:

- The number of parallel paths is automatically considered in the results.
- The test is always operated by considering a star winding connection.

By default, this input is equal to 0.2 volt.

The test procedure for performing the SSFR test consists in applying a fixed low voltage source between two terminals of the machine armature winding (Star winding connection) over a range of frequencies. SSFR voltage corresponds to the voltage source magnitude (U) applied.

For additional information please refer to the main principles of computation, section

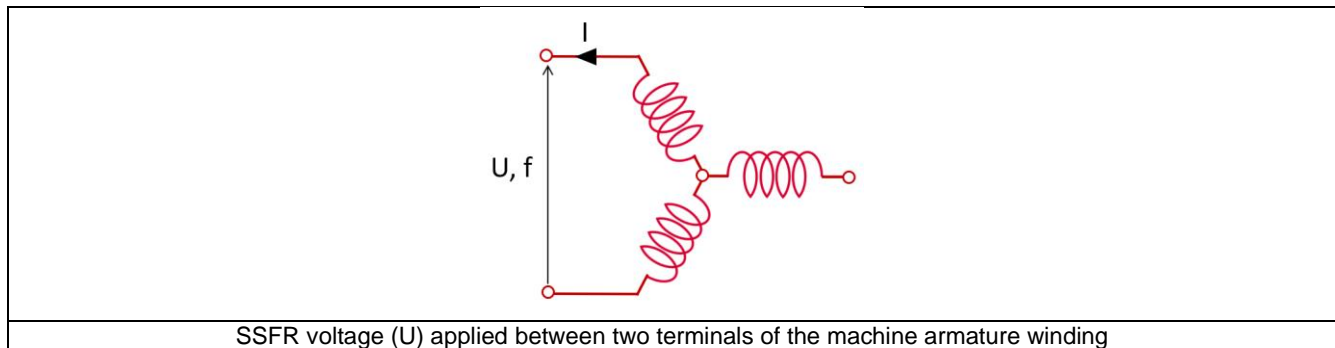

2.3.3.8 Skew model – Number of layers

When the rotor bars or the stator slots are skewed, the number of layers used in Flux® Skew environment to model the machine can be modified: “**Skew model - No. of layers**” (*Number of layers for modelling the skewing in Flux® Skew environment*).

2.3.3.9 Airgap mesh coefficient

The advanced user input “**Airgap mesh coefficient**” is a coefficient which adjusts the size of mesh elements inside the airgap. When the value of “**Airgap mesh coefficient**” decreases, the mesh elements get smaller, leading to a higher mesh density inside the airgap, increasing the computation accuracy.

The imposed Mesh Point (size of mesh elements touching points of the geometry), inside the Flux® software, is described as:

$$\text{Mesh Point} = (\text{airgap}) \times (\text{airgap mesh coefficient})$$

Airgap mesh coefficient is set to 1.5 by default.

The variation range of values for this parameter is [0.05; 2].

Giving 0.05 produces a very high mesh density and giving 2 a very coarse mesh density.

Caution:

Be aware, a very high mesh density does not always mean a better result quality. However, this always leads to a huge number of nodes in the corresponding finite element model. So, it means a need of huge numerical memory and increases the computation time considerably.

2.4 Main principles of computation

2.4.1 Introduction

As said previously, the aim of the test “Characterization – Model – Motor – SSFR” is to identify all the parameters of the electrical equivalent scheme of a 3-Phase squirrel cage induction machine by considering either a first order or a second order for the operational inductance transfer function $L(p)$.

2.4.2 Model representation

2.4.2.1 Second order model

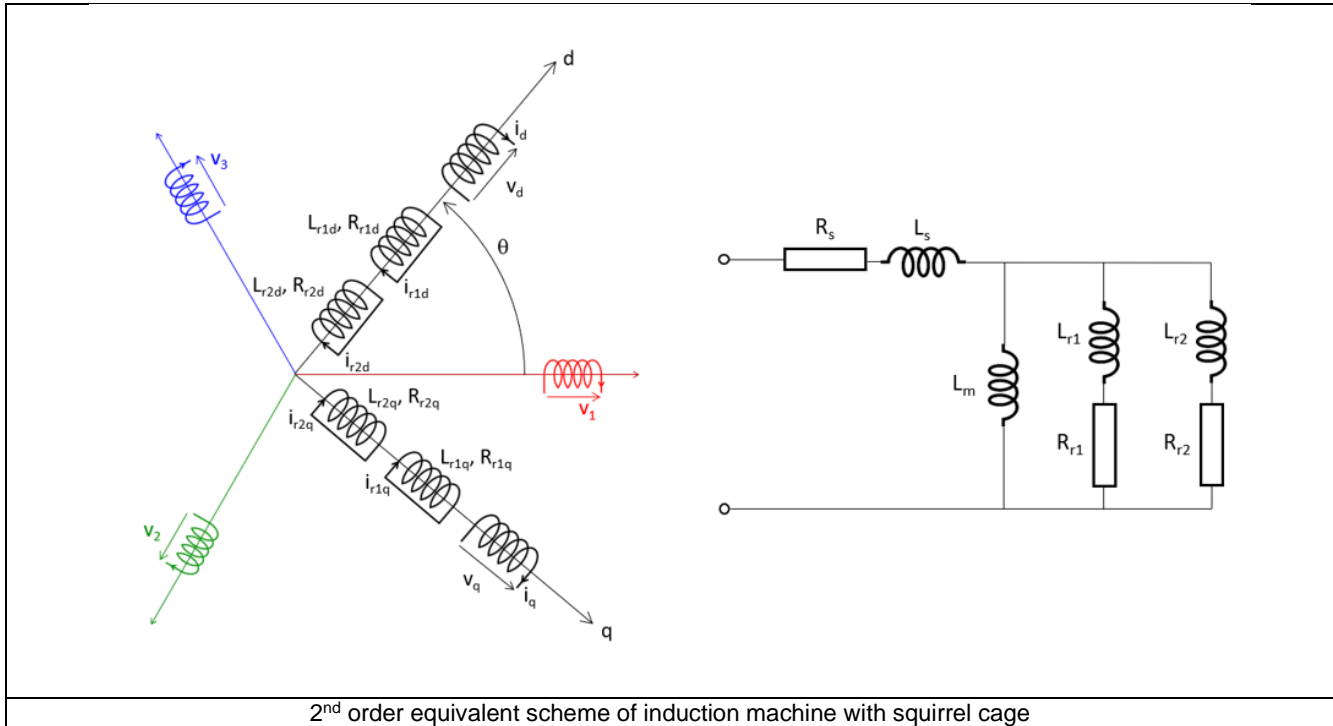

Notes:

Considering the topology of squirrel cage induction machines, the assumption considered is that there is no variation (or very low) of magnetic reluctance inside the airgap versus the rotor angular position.

The consequence is that both d-axis equivalent scheme and q-axis equivalent scheme are the same, hence:

$$L_{r1d} = L_{r1q} = L_{r1}$$

$$L_{r2d} = L_{r2q} = L_{r2}$$

$$R_{r1d} = R_{r1q} = R_{r1}$$

$$R_{r2d} = R_{r2q} = R_{r2}$$

On the previous graph, θ represents the relative position between the first stator winding phase and the d-axis of the machine model.

Here is the list of the second order equivalent scheme parameters:

R_s : Stator phase resistance

L_s : Stator phase leakage inductance = ($L_{sw} + L_{ss}$)

L_{sw} : Stator end winding leakage inductance (included in L_s)

L_{ss} : Stator straight part leakage inductance (included in L_s)

R_{r1} : Rotor squirrel cage resistance – 1st branch

L_{r1} : Rotor squirrel cage inductance – 1st branch

R_{r2} : Rotor squirrel cage resistance – 2nd branch

L_{r2} : Rotor squirrel cage inductance – 2nd branch

2.4.2.2 First order model

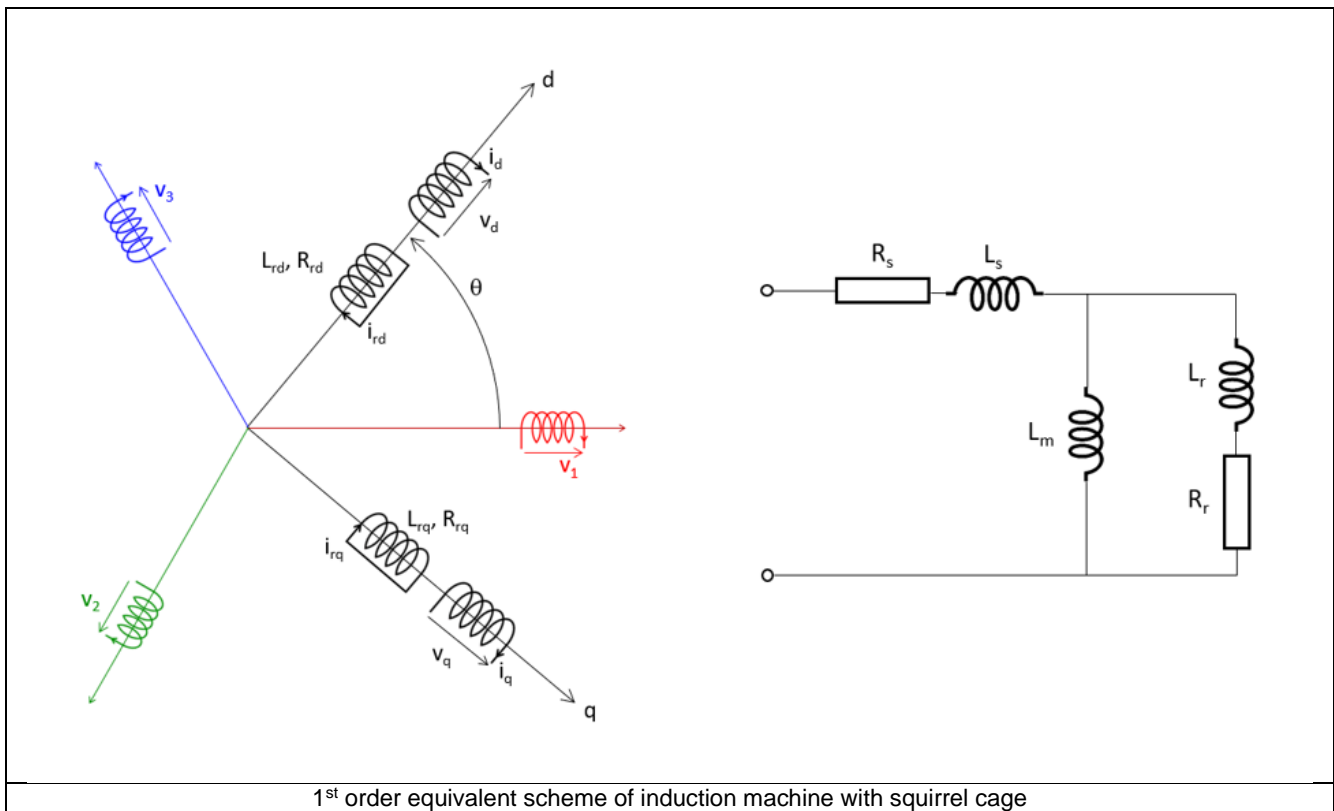

Notes:

Considering the topology of squirrel cage induction machines, the assumption considered is that there is no variation (or very low) of magnetic reluctance inside the airgap versus the rotor angular position.

The consequence is that both d-axis equivalent scheme and q-axis equivalent scheme are the same, hence:

$$L_{rd} = L_{rq} = L_r$$

$$R_{rd} = R_{rq} = R_r$$

On the previous graph, θ represents the relative position between the first stator winding phase and the d-axis of the machine model.

Here is the list of the first order equivalent scheme parameters:

R_s : Stator phase resistance

L_s : Stator phase leakage inductance = $(L_{sw} + L_{ss})$

L_{sw} : Stator end winding leakage inductance (included in L_s)

L_{ss} : Stator straight part leakage inductance (included in L_s)

R_r : Rotor squirrel cage resistance

L_r : Rotor squirrel cage inductance

Here are results to illustrate this comparison in the test area.

Blue points (curves) correspond to Finite Element computation results.

Black points (curves) correspond to analytical computations based on equivalent operational inductance transfer function.

The aim of the internal optimization process is to make these two resulting curves as close as possible from each other by taking action on the $L(p)$ parameters.

Modeling of an induction machine with squirrel cage - using a first order operational inductance

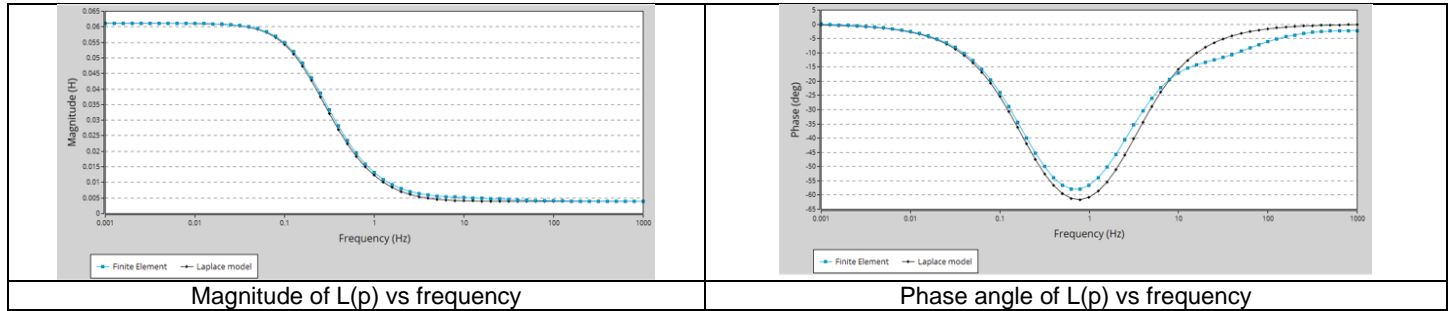

In this case, the first order is not enough accurate to make the resulting model correspond to the considered motor frequency-response.

Modeling of an induction machine with squirrel cage - using a second order operational inductance

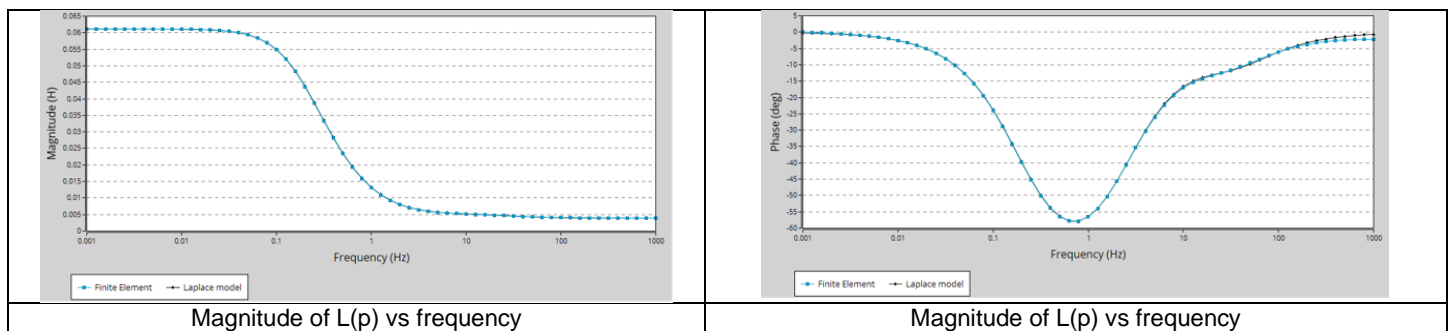

In this case, the second order allows to make the resulting model correspond to the considered motor frequency-response.

2.4.3.2 Additional information

1) Materials magnetic properties

To meet the requirements of the test assumptions, the computations with Finite Elements are operated by considering linear ferromagnetic materials.

The constant value of each material magnetic permeability is computed by considering a mean value in the very first part of the considered B(H) curve.

At a practical point of view, the constant magnetic permeability used in the computation is the average value of initial and the upper bound permeability defined as below illustrated.

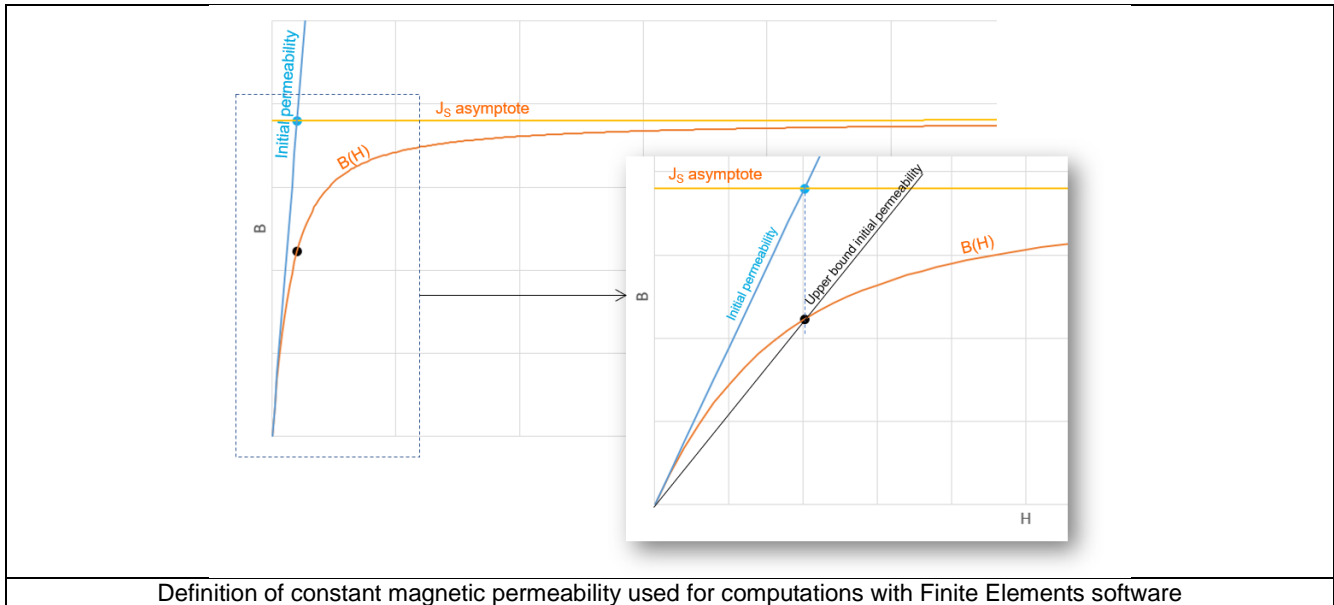

2) Stator phase leakage inductance computation

L_s is the stator phase leakage inductance is computed as followed:

L_{sw} is the stator end winding leakage inductance

L_{ss} is the stator straight part leakage inductance (including slot leakage inductance)

L_{sw} corresponds to the total end winding inductance (including the two sides of the machine). It is computed in the winding area environment with analytical method of computation.

The stator straight part leakage (L_{ss}) is computed from the magnetic energy stored in the slots along the half part of the airgap close to the stator bore diameter.

The total value of the stator phase leakage inductance (L_s) is computed as follows:

$$L_s = (L_{sw} + L_{ss})$$

The D-axis or Q-axis magnetization inductances are deduced using the following formulae:

$$L_{md} = L_{mq} = L_m = L_d - L_s$$

Where L_d is the D-axis phase winding inductance which corresponds to the A parameter of the operational inductance which corresponds to the inductance at low frequency.

$L(p) = A \frac{1 + Bp}{1 + Cp}$	$L(p) = A \frac{1 + Bp + Cp^2}{1 + Dp + Ep^2}$
1 st order operational inductance transfer function	2 nd order operational inductance transfer function

Considering the topology of induction machines with squirrel cage, one can assume that there is no variation (or very low) of magnetic reluctance inside the airgap versus the rotor angular position.

Therefore, both d-axis equivalent scheme and q-axis equivalent scheme are the same, hence: $L_d = L_q$

2.4.3.3 Model evaluation

Based on the equivalent scheme parameters obtained in the characterization part, the voltage and magnetic equations of the induction machine alongside with its mechanical equation are written and solved to simulate the behavior of the motor during a starting.

Thus, speed, electromagnetic torque and current versus time are computed and displayed. Synthesis of start-up characteristic are computed and displayed.

Here are illustrations of these outputs:

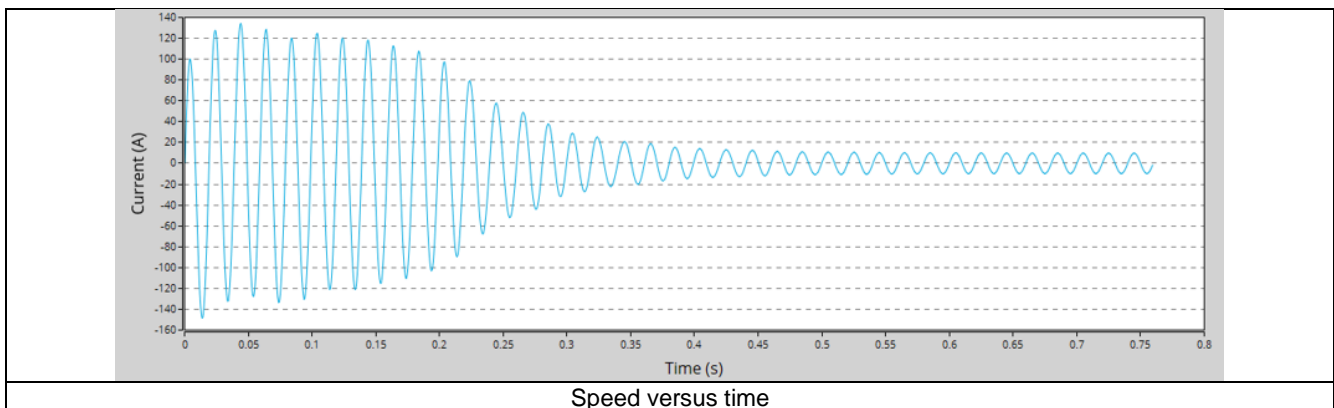
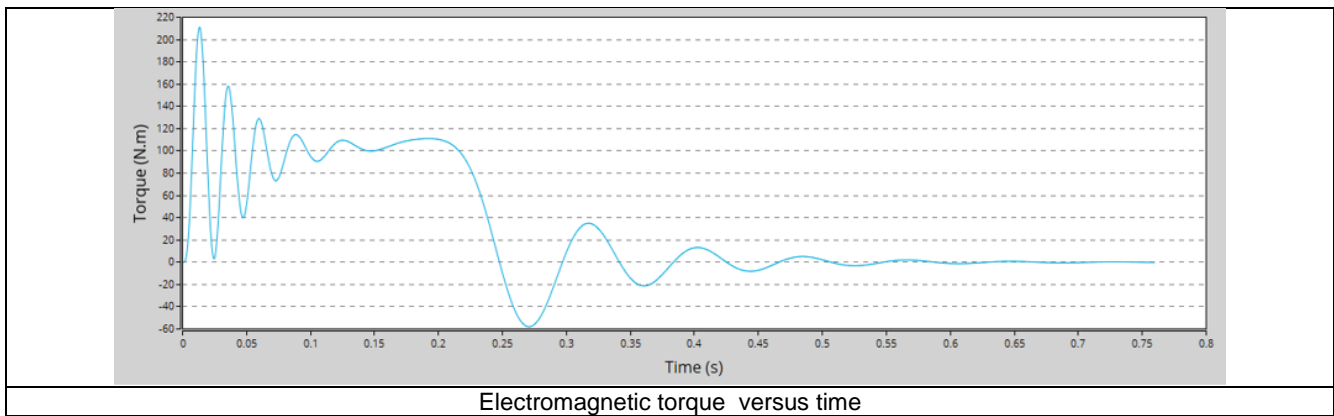
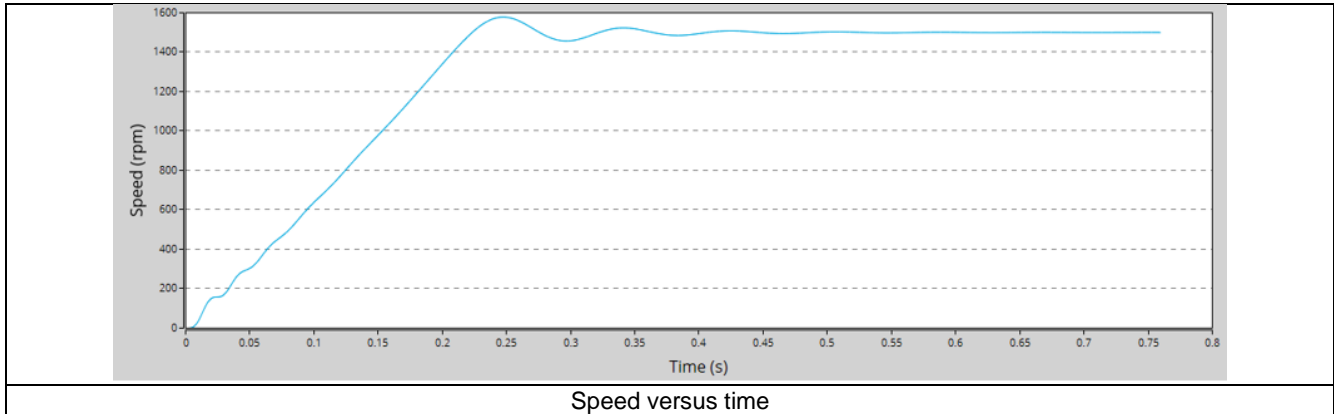

2.5 Test results

Once a test is finished, the corresponding results are automatically displayed in the central window.

2.5.1 Test conditions

2.5.1.1 Inputs

All the parameter values that belong to standard inputs or advanced inputs are described in this section. It shows the initial conditions considered for the test.

Here are the displayed subsections:

- Context
- Standard parameters
- Advanced parameters

2.5.1.2 Settings

All the settings dedicated to the test and dealing with the thermal are displayed in this section. Here is the displayed subsection:

- Thermal

2.5.1.3 Winding and squirrel cage characteristics

The winding and squirrel cage characteristics are displayed in the following subsections:

- Winding characteristics
- Squirrel cage characteristics

2.5.1.4 Inter bar resistance and inductance

Two curves representing the resistance and inductance versus frequency and considering the temperature of the squirrel cage components set by the user are displayed.

2.5.2 Main results

2.5.2.1 Operational inductance

Whatever is the considered operational inductance order, the corresponding theoretical transfer function is displayed. All the related coefficients of the operational inductance model are displayed.

Then, the magnitude and the phase angle of the operational inductance transfer function versus the frequency are displayed.

2.5.2.2 Equivalent circuit

Whatever is the considered operational inductance order, the corresponding equivalent scheme is displayed. All the related equivalent scheme parameters are displayed.

2.5.2.3 Model evaluation

Speed, electromagnetic torque, and current are displayed versus time

A table summarizes the start-up characteristics.

3 CHARACTERIZATION – MODEL – MOTOR – SCALAR

3.1 Overview

3.1.1 Positioning and objective

The aim of the test “**Characterization – Model – Motor – Scalar**” is to characterize the behavior of the machine in function of a set of Line-Line voltage (U) and a set of power supply frequency (f) (only motor operating mode available). Those computations are based on the identification and the solving of a non-linear model considering the cross saturation and the eddy current effects. All the main electromagnetic quantities are computed and displayed as curves in function of speed for a given power supply frequency and a set of Line-Line voltages.

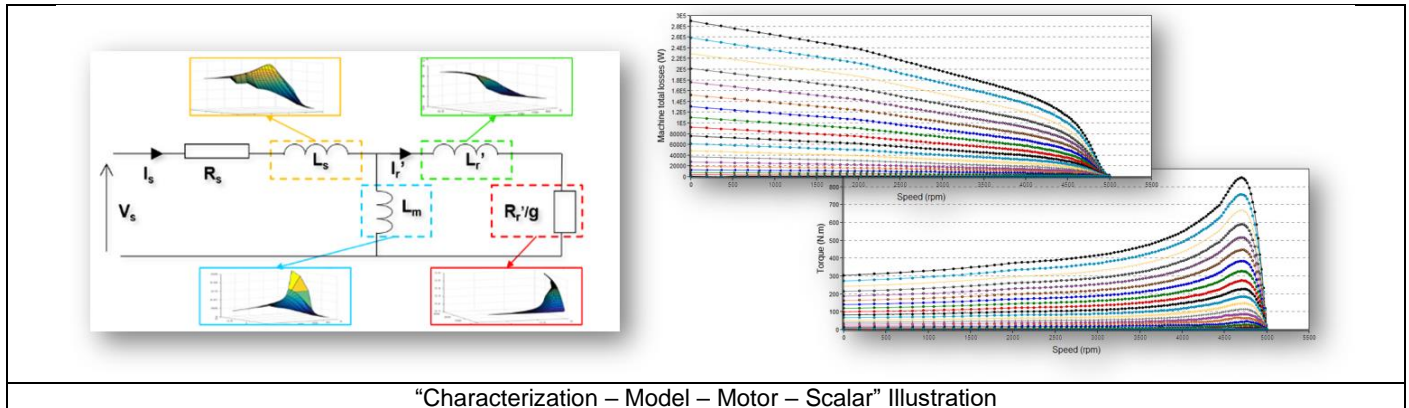

The results of this test give an overview of the electromagnetic behavior of the machine considering its topology. For a set of Line-Line voltages (U) and a set of power supply frequencies (f), the general parameters of the machine like, mechanical torque, currents, power factor and power balance are computed and displayed as curves.

This gives the capability to make comparisons between the results obtained from the measurements and those with the Altair® FluxMotor®.

In this test, system engineers will find a characterization tool adapted to their needs and able to provide accurate curves ready to be used in system simulation software like, Activate or PSIM. Indeed, from results obtained in this test, a scalar drive and control can be applied.

Note: We consider the motor convention.

The following table classifies the test “Characterization – Model – Motor – Scalar

Family	Characterization
Package	Model
Convention	Motor
Test	Scalar

Positioning of the test “Characterization – Model – Motor – Scalar”

3.1.2 User inputs

The four main user input parameters are the maximum Line-Line voltage, the Rated power supply frequency, the maximum line current and the maximum speed. In addition, the temperatures of winding and squirrel cage must be set in the power electronics, if needed.

3.1.3 Main outputs

Curves versus speed for a set of Line-Line voltage (U) and a set of power supply frequency (f)

- 1) Mechanical torque
- 2) Mechanical power
- 3) Machine efficiency
- 4) System efficiency
- 5) Machine electrical power
- 6) System electrical power
- 7) Machine total losses
- 8) System total losses
- 9) Stator total losses
- 10) Rotor total losses
- 11) Mechanical total losses
- 12) Power electronics losses
- 13) Power factor
- 14) Stator current

3.2 Settings

Three buttons give access to the following setting definition:

- Temperature of active components: winding and squirrel cage
- Definition of the power electronics parameters
 - Inverter control strategy
 - Inputs for evaluating the power electronics stage losses
- Definition of mechanical loss model parameters

For more details, please refer to the document: MotorFactory_2023_IMSQ_IOR_3PH_Test_Introduction.

- Import

Provide the ability to import the current inputs and results from the test “**Performance mapping – Sine wave – Motor – Efficiency map scalar**”. This will save the computation time related to the identification of the non-linear model, in other word, save the computation time related to the finite element solving which generally represent the main part of the computation time of the test.

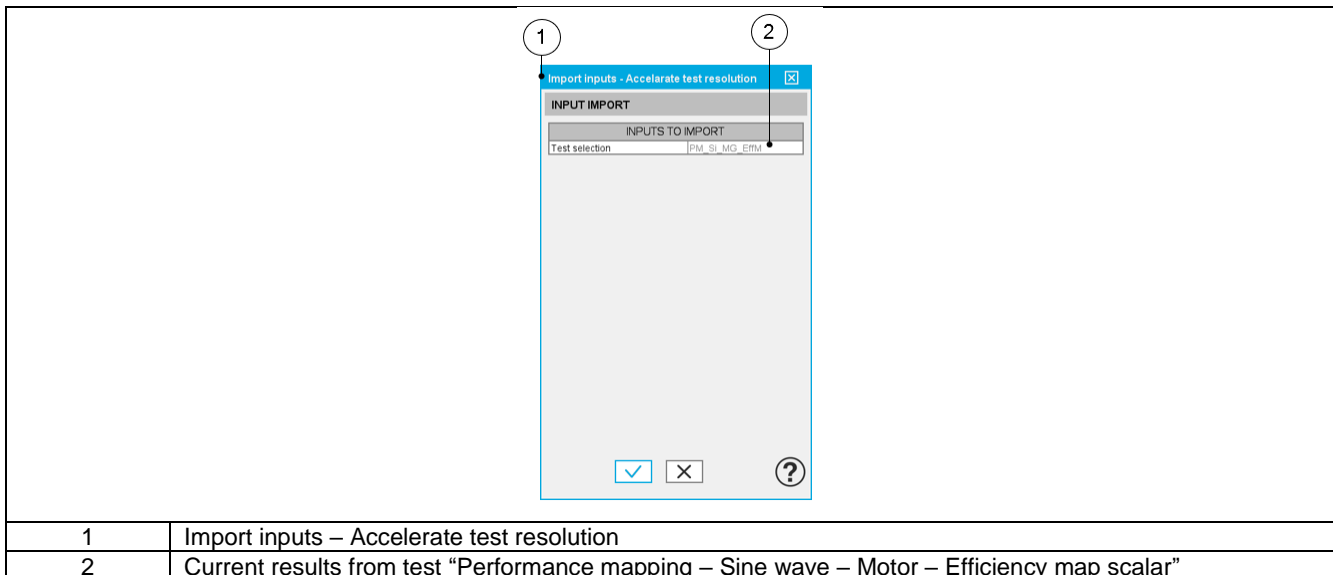

3.3 Inputs

3.3.1 Introduction

The total number of user inputs is equal to 11.
Among these inputs, 4 are standard and 7 are advanced inputs.

3.3.2 Standard inputs

3.3.2.1 Maximum Line-Line voltage, rms

The rms value of the maximum Line-Line voltage supplying the machine: “**Maximum Line-Line voltage, rms**” (*Maximum Line-Line voltage, rms value*) must be provided.

Note: The number of parallel paths and the winding connection are automatically considered in the results.

3.3.2.2 Rated power supply frequency

The value of the rated power supply frequency of the machine: “**Rated power supply frequency**” (*rated power supply frequency*) must be provided.

The rated power supply frequency is the electrical frequency applied at the terminals of the machine for the base speed point.

3.3.2.3 Maximum speed

The value of the « **Maximum speed** » (*Maximum speed*.) must be provided.

The analysis of the test results is performed over a given speed range defined between 0 and the maximum speed. This allows to evaluate the behavior of the machine as a function of speed (like rotor Joule losses, total losses, power factor...) in this range of speed.

3.3.3 Advanced inputs

3.3.3.1 Electrical equivalent scheme identification

In the first step of the internal process of computation, it is required to identify the model (non-linear electrical equivalent scheme). This implies the computation for each component of the electrical scheme (resistance and inductances maps) as a function of the Line-Line voltage and the power supply frequency.

Both following inputs allow to fix the discretization required to identify the non-linear model.

3.3.3.2 Model maps identification - Number of computations for Line-Line voltage

The number of computations for the voltage must be defined with the user input « **ID - No. Comp. for voltage** » (*Electrical equivalent scheme identification - Number of computations for Line-Line voltage*).

The default value is equal to 10. This default value provides a good tradeoff between the accuracy and the computation time. The minimum allowed value is 10.

Note: We recommend increasing « **ID - No. Comp. for voltage** » to at least to 15 in case of fractional slot per pole and per phase.

3.3.3.3 Model maps identification - Number of computations for power supply frequency

The number of computations for the frequency must be defined with the user input « **ID - No. Comp. for freq.** » (*Electrical equivalent scheme identification - Number of computations for power supply frequency*).

The default value is equal to 10. This default value provides a good tradeoff between the accuracy and the computation time. The minimum allowed value is 10.

Note: We recommend increasing « **ID - No. Comp. for freq.** » at least to 15 in case of fractional slot per pole and per phase.

3.3.3.4 Operation of the non-linear model to generate T(U,f,s)

In the second step of the internal process of computation, it is required to operate (solve) the model (non-linear electrical equivalent scheme) to generate sets of curves in function of the Line-Line voltage, the power supply frequency, and the slip to get the performances of the machine as in the T(Slip) test.

Forth following inputs allow to fix the discretization required to operate the non-linear model in order to get the data set of T(U,f,s) curves representing the behavior of the machine in function of the Line-Line voltage, the power supply frequency and the slip(or speed).

3.3.3.5 Operation of model to generate T(U,f,s) - Number of computations for Line-Line voltage

The number of computations for the voltage must be defined with the user input « **Op. - No. comp. for voltage** » (Operation of model to generate T(U,f,s) - Number of computations for Line-Line voltage). The default value is equal to 20. This default value provides a good overview of the machine behavior. The minimum allowed value is 10.

Note: The computation time of the test is not highly impacted by this input and huge values can be used as in the test Scalar EM in which the default value is 300.

3.3.3.6 Operation of model to generate T(U,f,s) - Number of computations for power supply frequency

The number of computations for the frequency must be defined with the user input « **Op. - No. comp. for freq.** » (Operation of model to generate T(U,f,s) - Number of computations for power supply frequency). The default value is equal to 30. This default value provides a good overview of the machine behavior. The minimum allowed value is 10.

Note: The computation time of the test is not highly impacted by this input, and huge values can be used as in the test Scalar EM in which the default value is 500.

3.3.3.7 Operation of model to generate T(U,f,s) – Slip distribution mode

The computation of the test « **Characterization – Model – Motor – Scalar** » is performed by considering a distribution of computed points. The user's input "**Slip distribution mode**" (*Select the method for the distribution of computed points*) gives three possibilities to the user:

1) Slip distribution mode = Logarithmic

When "Logarithmic" is selected, the distribution of the computed points is automatically done. The number of computations to be done in the slip range must be set in the next field: "No. comp. in slip range".

2) Slip distribution mode = Linear

When "Linear" is selected, the distribution of the computed points is automatically done. The number of computations to be done in the slip range must be set in the next field: "No. comp. in slip range".

3) Slip distribution mode = Table

When "Table" is selected, the list of slips to be considered must be defined by using the next field: "Slip table" and by clicking on the button "Set values".

Two ways are possible to fill the table: either filling the table line by line or by importing an excel file where all the slips to be considered are defined.

Note: The slips must be listed in ascending order.

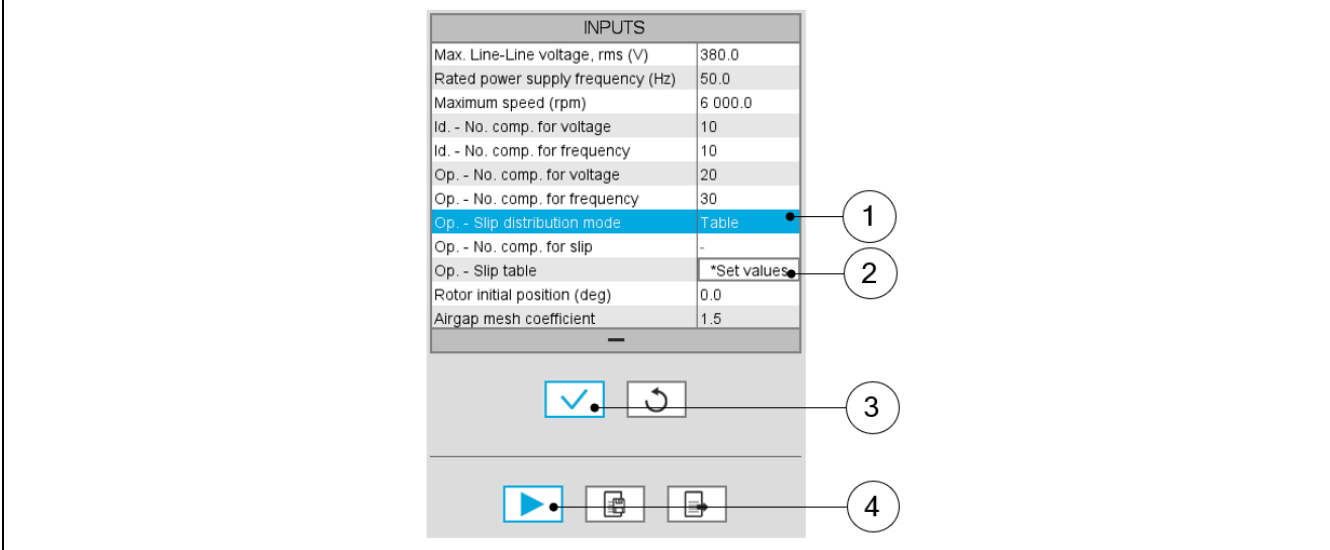

INPUTS	
Max. Line-Line voltage, rms (V)	380.0
Rated power supply frequency (Hz)	50.0
Maximum speed (rpm)	6 000.0
Id. - No. comp. for voltage	10
Id. - No. comp. for frequency	10
Op. - No. comp. for voltage	20
Op. - No. comp. for frequency	30
Op. - Slip distribution mode	Table
Op. - No. comp. for slip	-
Op. - Slip table	*Set values
Rotor initial position (deg)	0.0
Airgap mesh coefficient	1.5

Slip distribution mode = Table	
1	Select the "Table" option.
2	Click the button "Set values" of the field "Slip table" to open a dialog box to define the list of slips to be considered. Refer to the next illustration which shows how to fill the Slip table.
3	Button to validate and consider the user inputs
4	Button to run the computation

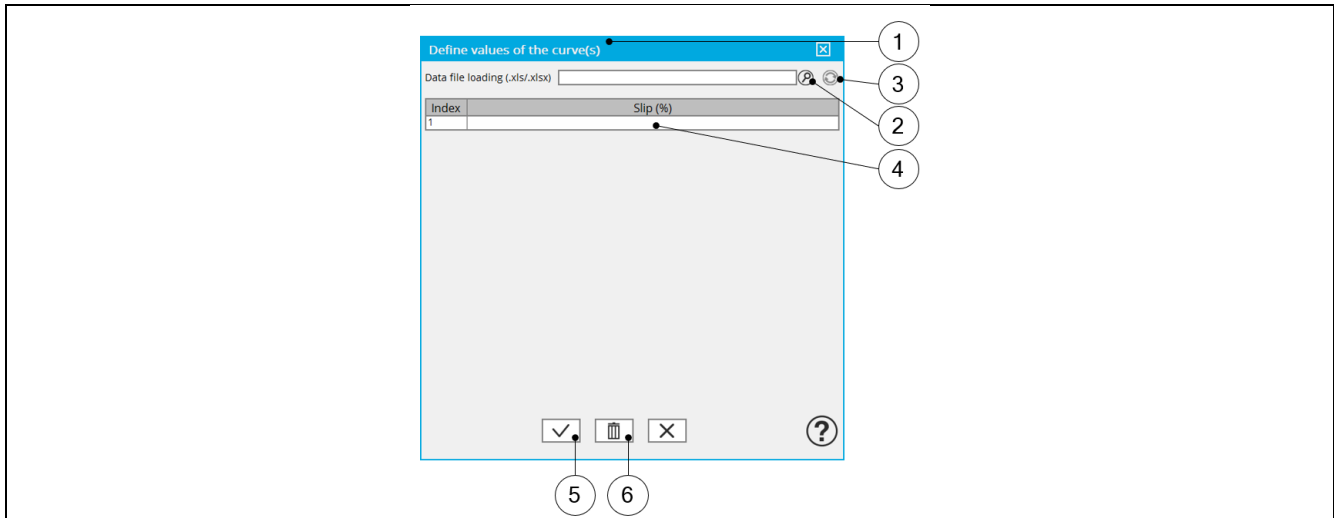

Slip distribution mode = Table – Dialog box to define the list of slips

1	Dialog box opened when clicked on the button “Set values” in the field “Slip table”
2	Browse the folder to select an Excel file which defined the list of slips
3	Button to refresh the table data when the considered Excel file has been modified
4	Fields to be filled with data to describe the considered slips
5	Button to apply the inputs
6	Button to erase the data table

Note: The Excel template used to import a list of slips is stored in the folder Resource/Template in the installation folder of FluxMotor®. An example of this template is displayed below.

Slip table	
Label	Slip
Units	%
Values	2
	5
	10
	20

Excel file template to define the list of slips

Note: The slips must be listed in ascending order, and we recommend defining at least a hundred values.

4) Operation of model to generate T(U,f,s) - Number of computations for slip

The number of computations for the slip must be defined with the user input « **Op. - No. comp. for slip** » (Operation of model to generate T(U,f,s) - *Number of computations for slip*).

The default value is equal to 100. This default value provides a good overview of the machine behavior. The minimum allowed value is 10.

Note:

- The machine operating mode is “Motor”, so the slip range is [0,1].
- The slip distribution mode used is logarithmic or linear.
- The computation time of the test is not highly impacted by this input and huge values can be used if needed as 200.

3.3.3.8 Operation of model to generate T(U,f,s) – Slip table

When the choice of point distribution mode is “**Table**”, the list of slips to be considered “**Op. - Slip table**” (Operation of model to generate T(U,f,s) - *Slip table*) must be provided. Refer to the above section 2) Slip distribution mode = Table

Note: The machine operating mode is fixed to “Motor”, so the slip range is]0,1].

3.3.3.9 Skew model – No. of layers

When the rotor bars or the stator slots are skewed, the number of layers used in Flux® Skew environment to model the machine can be modified: “**Skew model - No. of layers**” (*Number of layers for modelling the skewing in Flux® Skew environment*).

3.3.3.10 Rotor initial position

The initial position of the rotor considered for computation can be set by the user in the field « **Rotor initial position** » (*Rotor initial position*). The default value is equal to 0.

The range of possible values is [-360, 360].

Note: The rotor initial position has an impact only on the induction curve in the air gap.

3.3.3.11 Airgap mesh coefficient

The advanced user input “**Airgap mesh coefficient**” is a coefficient which adjusts the size of mesh elements inside the airgap. When the value of “Airgap mesh coefficient” decreases, the mesh elements get smaller, leading to a higher mesh density inside the airgap, increasing the computation accuracy.

The imposed Mesh Point (size of mesh elements touching points of the geometry), inside the Flux® software, is described as:

$$\text{Mesh Point} = (\text{airgap}) \times (\text{airgap mesh coefficient})$$

Airgap mesh coefficient is set to 1.5 by default.

The variation range of values for this parameter is [0.05; 2].

0.05 gives a very high mesh density and 2 gives a very coarse mesh density.

Caution:

Be aware, a very high mesh density does not always mean a better result quality. However, this always leads to a huge number of nodes in the corresponding finite element model. So, it means a need of huge numerical memory and increases the computation time considerably.

3.4 Main principles of computation

The documentation is under construction.

3.5 Test results

Once a test is finished, the corresponding results are automatically displayed in the central window.

3.5.1 Test conditions

3.5.1.1 Inputs

All the parameter values, belonging to standard inputs or advanced inputs are described in this section. It shows the initial conditions considered for the test.

Here are the displayed subsections:

- Context
- Standard parameters
- Advanced parameters

For more details, please refer to the document: [MotorFactory_2023_IMSQ_IOR_3PH_Test_Introduction](#).

3.5.1.2 Settings

All the settings dedicated to the test and dealing with the thermal are displayed in this section.

Here is the displayed subsection:

- Thermal
- Electronics
- Mechanics

3.5.1.3 Winding and squirrel cage characteristics

All winding and squirrel cage characteristics are displayed in the following subsections:

- Winding characteristics
- Squirrel cage characteristics

3.5.1.4 Inter bar resistance versus rotor frequency over the operating range

Curve which allows to see the evolution of the inter bar resistance in function of the rotor frequency.

Note: These values are those considered for the identification of the non-linear model.

3.5.1.5 Inter bar inductance versus rotor frequency over the operating range

Curve which allows to see the evolution of the inter bar inductance in function of the rotor frequency.

Note: These values are those considered for the identification of the non-linear model.

3.5.2 Main results

3.5.2.1 Machine performance – Starting torque

For all the considered working point (Starting torque, Break down torque - Motor mode, Break down torque - Generator mode, Minimum breaking torque or User working point) the output data is displayed.

Here are the displayed subsections:

- General data
- Machine constants
- Power balance
- Flux in airgap
- Flux density in iron

3.5.2.2 Power electronics

- Inverter

When power electronics stage is selected by the user, the inverter control strategy and the DC bus voltage are reminded. For information, the corresponding maximum line-line voltage rms value is computed and displayed.

- Working point

The power balance and the corresponding efficiencies are computed and displayed for the machine, the power electronics stage and for the system (i.e. machine + power electronics stage).

For more details, please refer to the document: [MotorFactory_2023_IMSQ_IOR_3PH_Test_Introduction](#).

3.5.3 Curves

- Mechanical torque
- Mechanical power
- Machine efficiency
- System efficiency
- Machine electrical power
- System electrical power
- Machine total losses
- System total losses
- Stator total losses
- Rotor total losses
- Mechanical total losses
- Power electronics losses
- Power factor
- Stator current

3.5.4 Characteristics curves

- Normalized base point curves

4 CHARACTERIZATION – THERMAL – MOTOR & GENERATOR – STEADY STATE

4.1 Overview

4.1.1 Positioning and objective

The aim of the test “Characterization – Thermal – Motor & Generator – Steady state” is to evaluate the impact of electromagnetic performance on the thermal behavior of the machine.

A thermal working point defined by a speed and a set of losses can be considered to compute the temperature charts and the main thermal parameters. The inputs describing the thermal working point can be set manually or imported from some electromagnetic tests previously solved.

This test helps to answer the following questions:

- Can the machine operate at the targeted working point without any overheating? Yes / No
- Can the different kinds of proposed cooling help to reach good performance? Yes / No

The following table helps to classify the test “Characterization – Thermal – Motor & Generator – Steady state”.

Family	Characterization
Package	Thermal
Convention	Motor & Generator
Test	Steady state

Positioning of the test “Characterization – Thermal – Motor & Generator – Steady state”.

4.1.2 User inputs

The main inputs are the losses to be considered for evaluating the corresponding thermal behavior of the machine and the speed.

4.1.3 Main outputs

Here are the main results available:

- Temperature charts – radial and axial view
- Temperature table
- Main thermal parameters

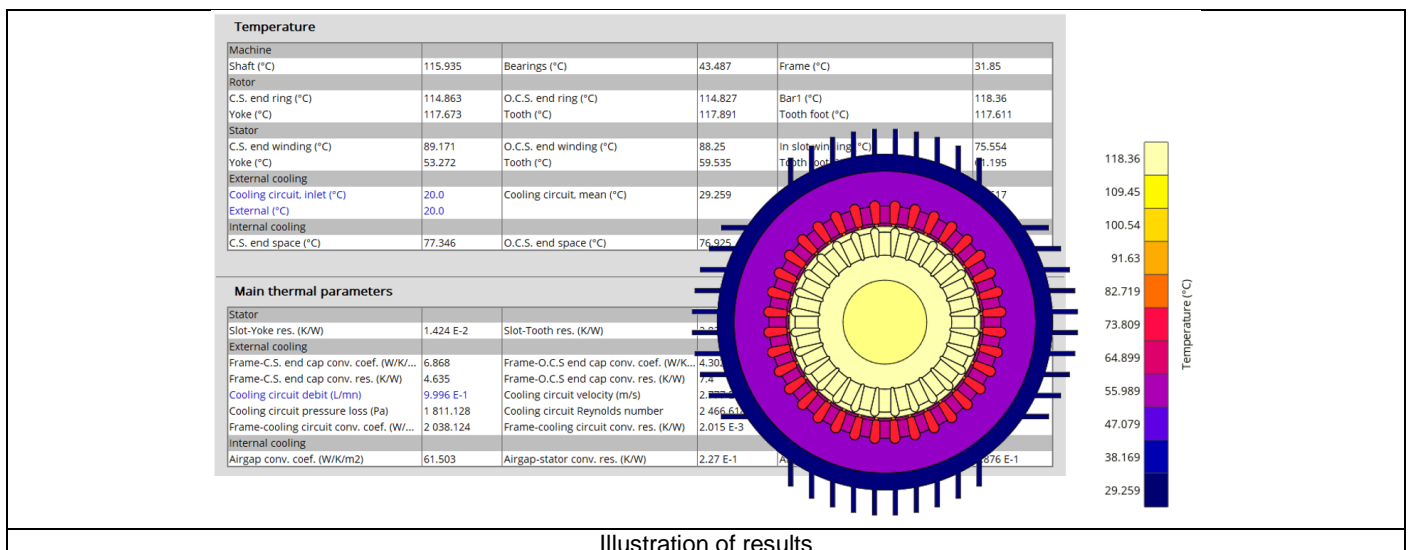

4.2 Settings

One button gives access to the thermal settings:

- External fluid temperature
- Cooling circuit fluid temperature

Note 1: The external fluid temperature corresponds to the temperature of the fluid surrounding the machine. It is also considered as the temperature at the “infinite” for the computation of radiation from the frame to the infinite.

Note 2: The cooling circuit fluid temperature is relevant only when a cooling circuit has been added by the user in the design environment. In this case, this input describes its fluid inlet temperature.

4.3 Inputs

4.3.1 Introduction

The main inputs of these test correspond to a set of losses to be considered for evaluating the thermal behavior of the machine.

4.3.2 Standard inputs

4.3.2.1 Speed

The speed of the machine to be considered.

4.3.2.2 Set of losses

The losses to be defined are the following ones:

- Stator Joule losses
- Stator iron losses
- Magnet losses
- Rotor iron losses
- Mechanical losses

4.3.2.3 Input import

The set of inputs can be imported from another test already performed in Motor Factory Test environment. It can be current results or saved test results.

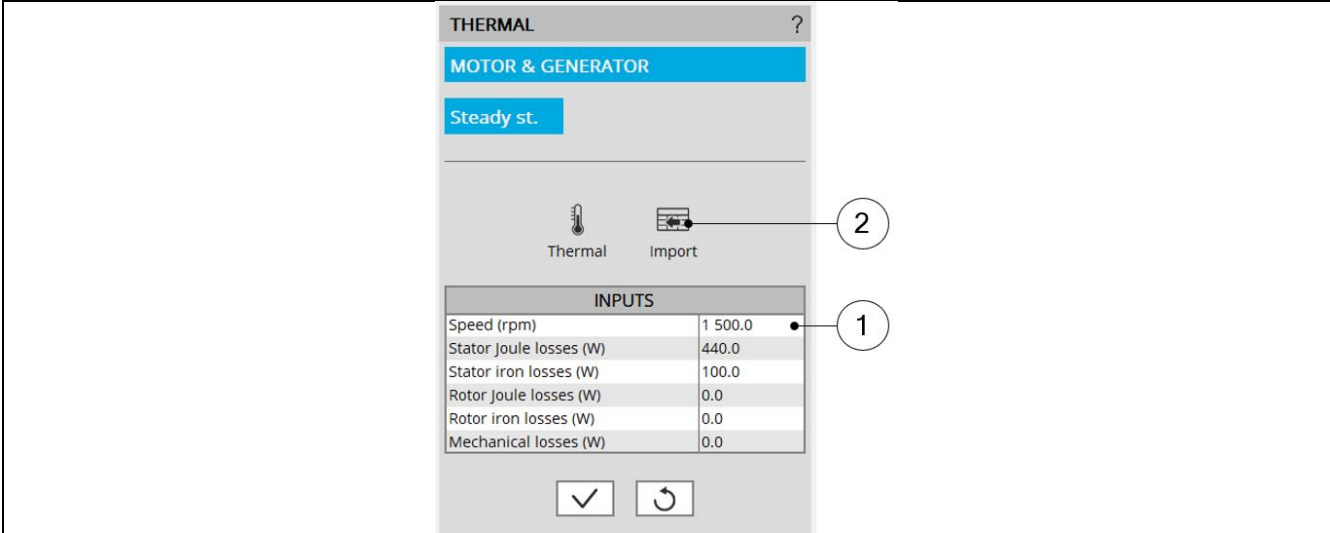

INPUTS	
Speed (rpm)	1 500.0
Stator joule losses (W)	440.0
Stator iron losses (W)	100.0
Rotor joule losses (W)	0.0
Rotor iron losses (W)	0.0
Mechanical losses (W)	0.0

How to define a set of losses

1	Fill in the table to define the speed and all the losses to be considered
2	Click on the button “import” to import inputs corresponding to a solved test. All existing data of the selected test will be imported into the inputs of the thermal characterization. The data which does not exist in the outputs of the selected test are set to 0.

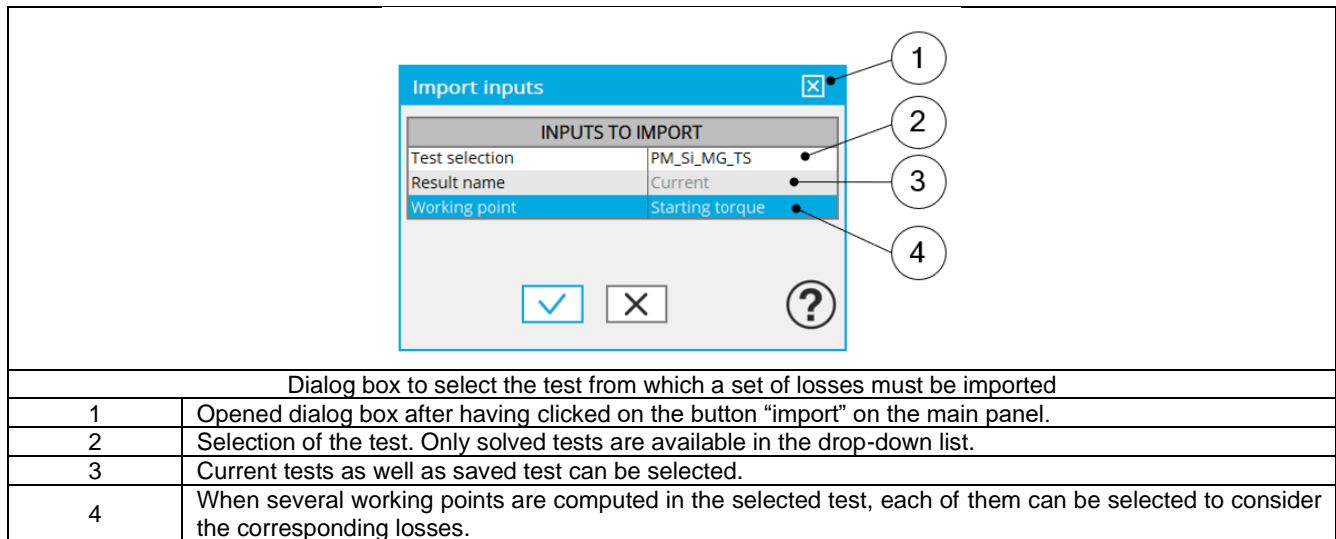

Note: The imported data are the data directly shown in outputs of the considered solved test. For some tests, some values are not defined like for instance the Joule magnet losses or rotor iron losses). In that case, the corresponding values are set to 0 in the thermal characterization input table.

4.3.3 Advanced input

There are no advanced inputs required for this test.

4.4 Main principles of computation

4.4.1 Introduction

Here are illustrations which give an overview of the thermal test:

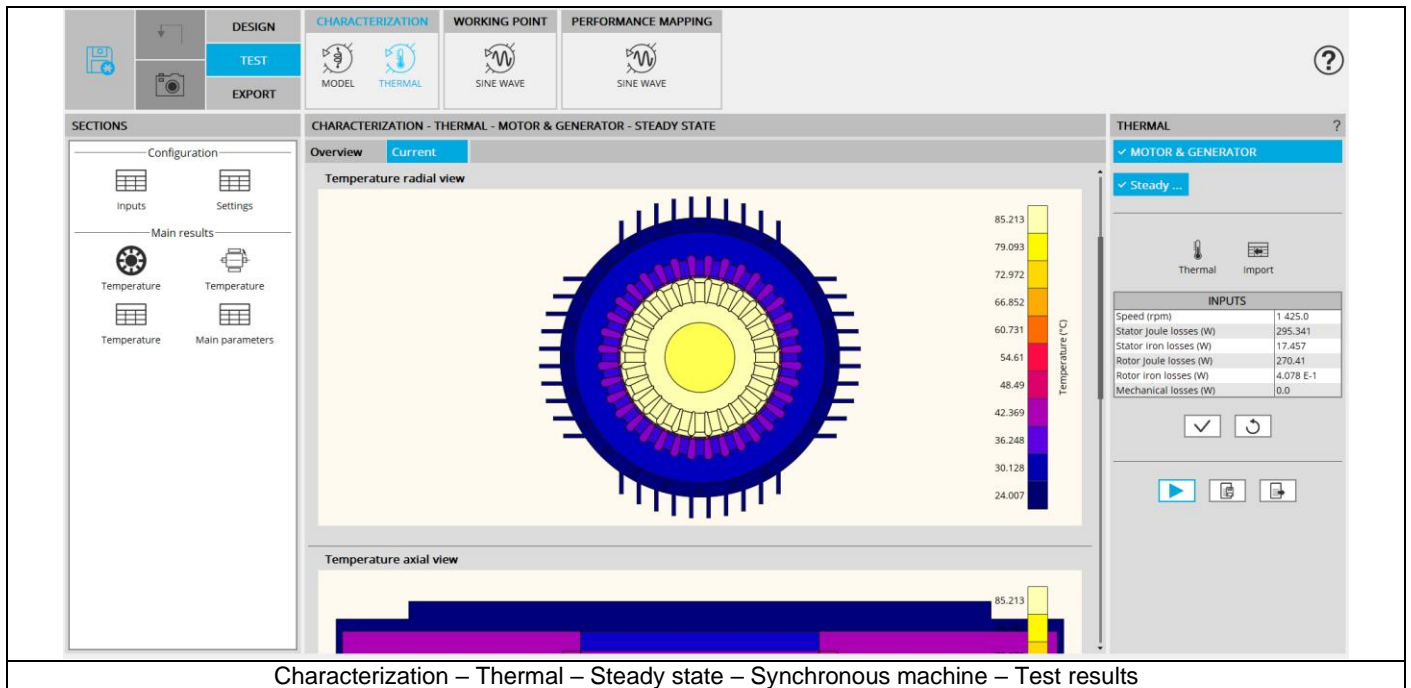
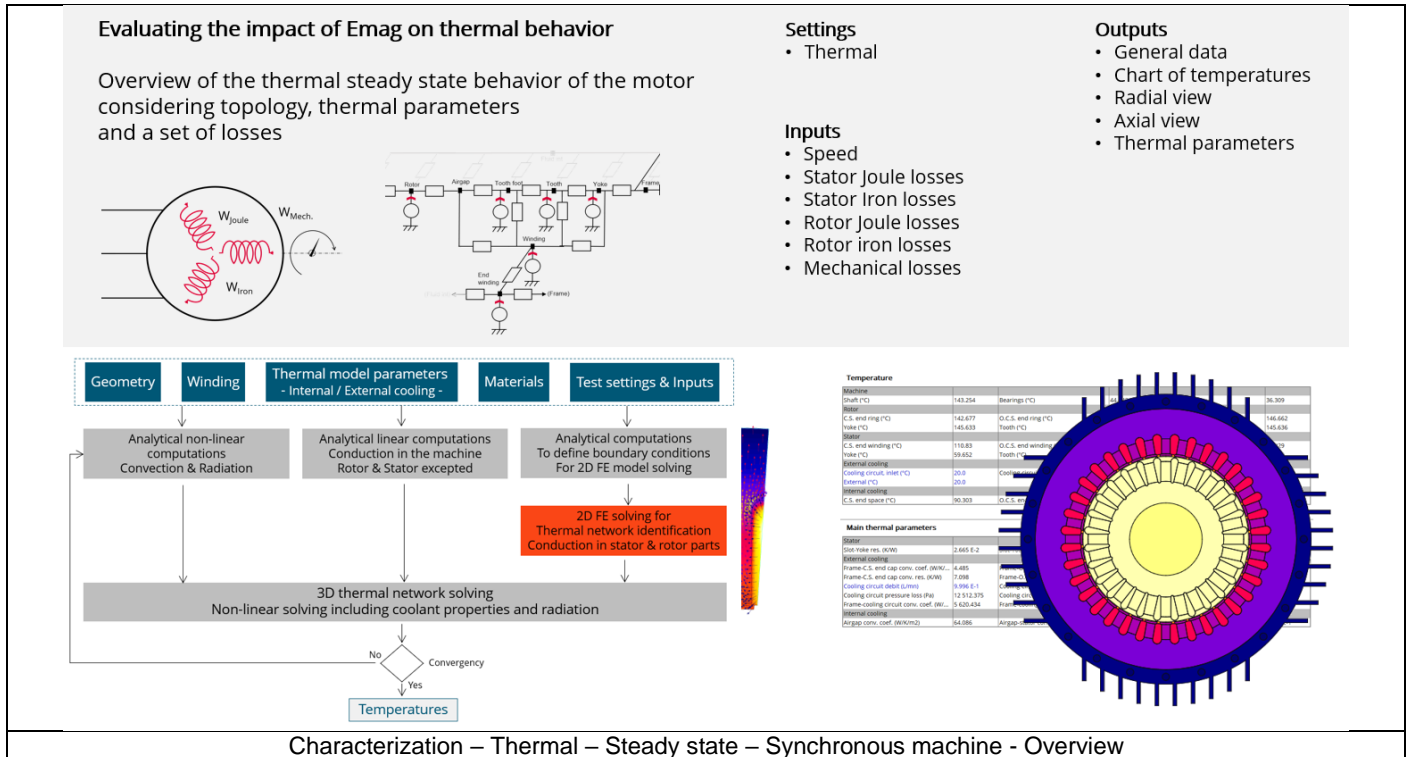

4.4.2 Flow chart

Here is the flowchart illustrating the internal process of the thermal test.

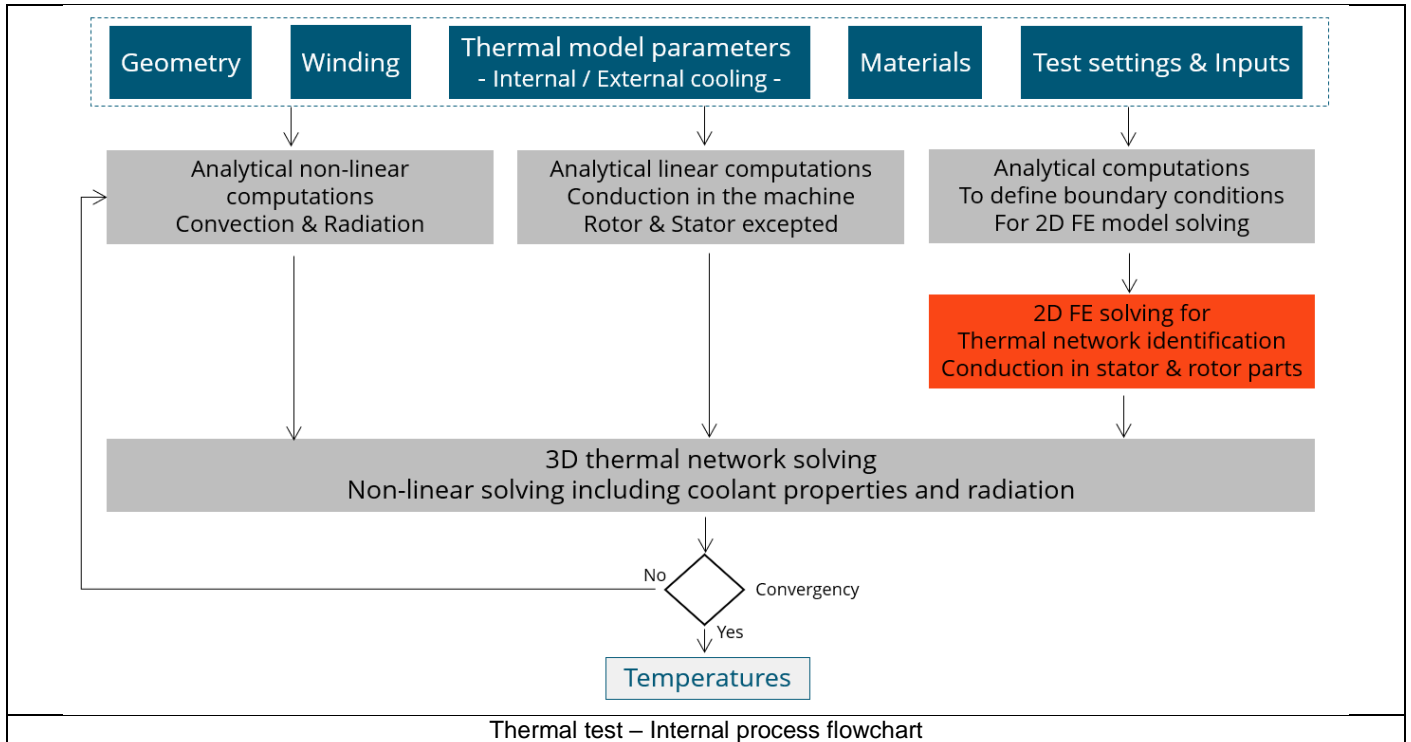

The inputs of the internal process are the parameters of:

- Geometry
- Winding
- Internal cooling
- External cooling
- Materials
- Test settings and inputs

To be underlined that a 2D Finite Elements model is solved to identify a thermal network which corresponds accurately to any kind of rotor or stator parts, including user parts.

Then, the resulting network is extended with analytical computations to consider the 3D effect of the geometry.

The solving allows to get and to display the whole chart of temperatures of the machines.

4.5 Test results

Once a test is finished, the corresponding results are automatically displayed in the central window.

4.5.1 Test conditions

4.5.1.1 Inputs

The speed and the set of losses to be considered in the test are remind in the head of results

4.5.1.2 Settings

The thermal settings are reminded:

- External fluid temperature
- Cooling circuit temperature

4.5.2 Main results

- Temperature radial and axial views
- Temperature table

4.5.2.1 Main thermal parameters

1) For the stator

Label	Tooltip, note formula
Slot-Yoke res.	Slot-Yoke resistance
Slot-Tooth res.	Slot-Tooth resistance
Slot-Tooth foot res.	Slot-Tooth foot resistance

Each of these resistances corresponds to the thermal total resistance computed between the in-slot winding and the corresponding part of the magnetic circuit. In each case, it includes two resistances in series:

- The conduction resistance through the winding and the magnetic circuit
- The conduction resistance through the possible interface gaps between the slot and the magnetic circuit

2) For External cooling

Label	Tooltip, note formula
Frame-C.S. end cap conv. coef.	Frame-Connection Side end cap convection coefficient When a forced convection is defined, this coefficient is the total resulting convection coefficient corresponding to the mix of natural and forced convection on the end cap.
Frame-O.C.S. end cap conv. coef.	Frame-Opposite Connection Side end cap convection coefficient When a forced convection is defined, this coefficient is the total resulting convection coefficient corresponding to the mix of natural and forced convection on the end cap.
Frame straight part conv. coef.	Frame-Straight part convection coefficient When a forced convection is defined, this coefficient is the total resulting convection coefficient corresponding to the mix of natural and forced convection on the straight part of the frame.
Frame-C.S. end cap conv. res.	Frame-Connection Side end cap convection resistance When a forced convection is defined, this resistance is the total resulting convection resistance corresponding to the mix of natural and forced convection on the end cap.
Frame-O.C.S. end cap conv. res.	Frame-Opposite Connection Side end cap convection resistance When a forced convection is defined, this resistance is the total resulting convection resistance on Opposite Connection Side end cap, corresponding to the mix of natural and forced convection on the end cap.
Frame straight part conv. res.	Frame-Straight part convection resistance When a forced convection is defined, this resistance is the total resulting convection resistance corresponding to the mix of natural and forced convection on the straight part of the frame.
Cooling circuit debit	Cooling circuit debit
Cooling circuit velocity	Cooling circuit velocity
Cooling circuit section	Cooling circuit section
Cooling circuit pressure	Cooling circuit regular pressure loss The singular pressure loss (for instance corresponding to duct bends, inlet and outlet duct shapes) are not taken into account in this pressure loss.
Cooling circuit Reynolds number	Cooling circuit Reynolds number
Cooling circuit roughness	Cooling circuit roughness
Frame-cooling circuit conv. coef.	Frame-cooling circuit convection coefficient
Frame-cooling circuit conv. res.	Frame-cooling circuit convection resistance

3) For internal cooling

Label	Tooltip, note formula
Airgap conv. coef.	Airgap convection coefficient
Airgap-stator conv. res.	Airgap-stator convection resistance
Airgap-rotor conv. res.	Airgap-rotor convection resistance

4.5.3 Limitation of thermal computations – Advice for use

Please refer to the document: MotorFactory_2023_IMSQ_IOR_3PH_Test_Introduction – section “Limitation of thermal computations – Advice for use”

5 CHARACTERIZATION – THERMAL – MOTOR & GENERATOR – TRANSIENT

5.1 Overview

5.1.1 Positioning and objective

The aim of “Characterization – Thermal – Motor & Generator – Transient” test is to evaluate the impact of electromagnetic performance on thermal behavior of the machine in a transient mode.

A thermal working point defined by a speed and a set of losses can be considered to compute the temperature charts and the main thermal parameters. The inputs describing the thermal working point can be set manually or imported from electromagnetic tests that were previously solved.

In addition to that, a maximum evaluation duration and a time step are added as inputs to set the transient mode.

This test helps to answer the following questions:

- Can the machine operate at the targeted working point without any overheating? Yes / No
- Can the different kinds of proposed cooling help to reach good performance? Yes / No
- How long does it take to reach the thermal steady state and what are the thermal time constants of the machine?

The following table helps to classify the test “Characterization – Thermal – Motor & Generator – Steady state”.

Family	Characterization
Package	Thermal
Convention	Motor & Generator
Test	Transient

Positioning of the test “Characterization – Thermal – Motor & Generator – Transient”

5.1.2 User inputs

The main inputs are the losses to be considered for evaluating the corresponding thermal behavior of the machine, the speed, a maximum evaluation duration and a time step.

5.1.3 Main outputs

Here are the main results available:

- Temperature charts versus time – radial and axial view
- Main temperature curve versus time and final temperature table
- Heat capacity and time constant table

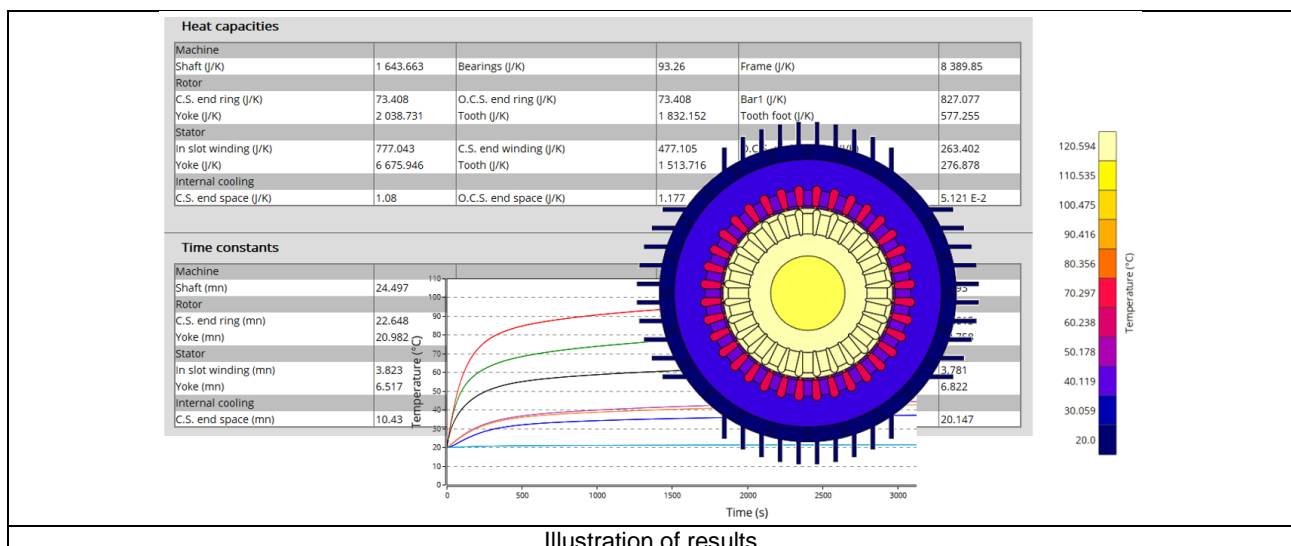

5.2 Settings

One button gives access to the thermal settings:

- External fluid temperature
- Cooling circuit fluid temperature

Note 1: The external fluid temperature corresponds to the temperature of the fluid surrounding the machine. It is also considered as the temperature at the “infinite” for the computation of radiation from the frame to the infinite.

Note 2: The cooling circuit fluid temperature exists only when a cooling circuit has been added by the user in the design environment. In this case, this input describes its fluid inlet temperature.

5.3 Inputs

5.3.1 Introduction

The main inputs of this test correspond to a set of losses to be considered for evaluating the thermal behavior of the machine in a transient mode.

5.3.2 Standard inputs

5.3.2.1 Speed

The speed of the machine to be considered.

5.3.2.2 Set of losses

The losses to be defined are the following ones:

- Stator Joule losses
- Stator iron losses
- Rotor Joule losses
- Rotor iron losses
- Mechanical losses

5.3.2.3 Time definition

The time during which the test is performed, defined by:

- Maximum evaluation duration
- Time step

5.3.2.4 Input import

The set of inputs concerning the speed and the losses, can be imported from another test already performed in Motor Factory Test environment.

It can be current results or saved test results.

Then the duration of the evaluation and the time step must be defined.

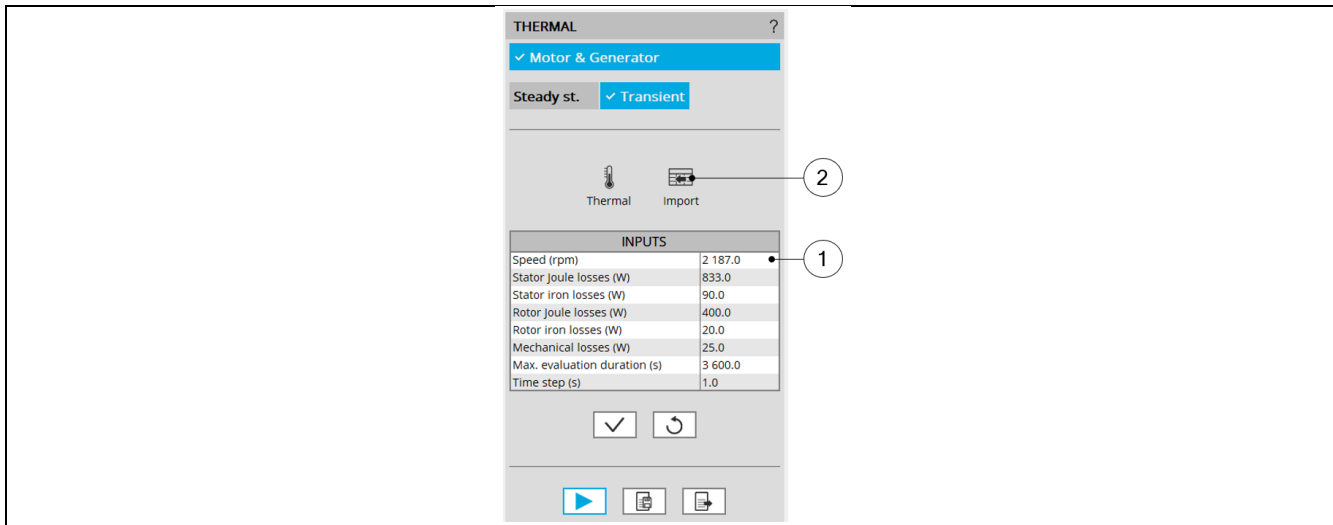

How to define the inputs

1	Fill in the table to define the speed, all the losses to be considered, the max evaluation duration and the time step.
2	Click on the button "import" to import inputs corresponding to a solved test. All existing data of the selected test will be imported into the inputs of the thermal characterization. The data which does not exist in the outputs of the selected test are set to 0.

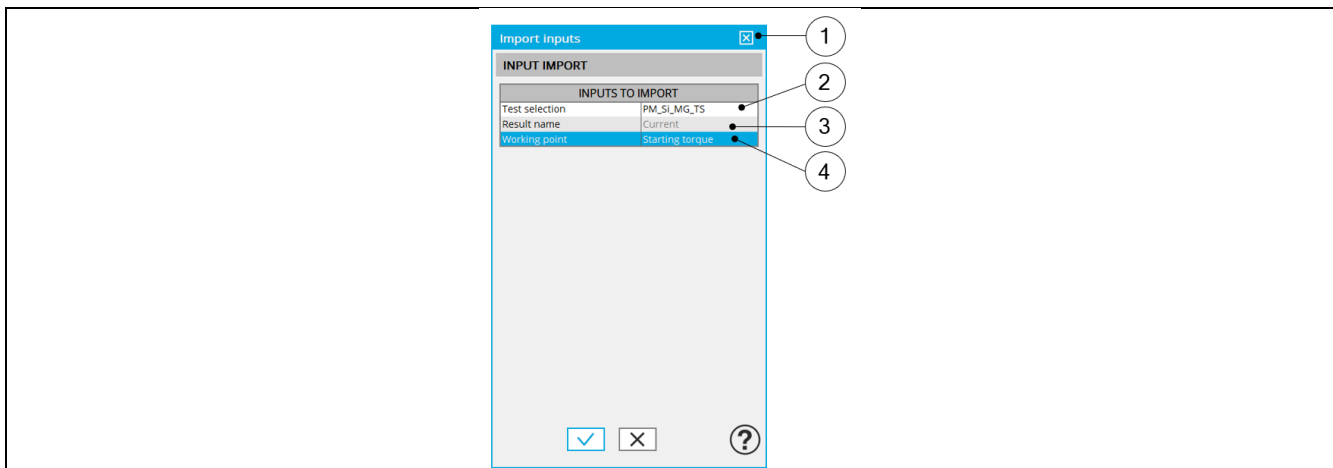

Dialog box to select the test from which a set of losses must be imported

1	Opened dialog box after having clicked on the button "import" on the main panel.
2	Selection of the test. Only solved tests are available in the drop-down list.
3	Current tests as well as saved test can be selected.
4	When several working points are computed in the selected test, each of them can be selected to consider the corresponding losses and speed.

Note: The imported data are the output data directly shown in the considered solved test. For some tests, some values are not defined (like for instance the rotor iron losses or the Mechanical losses). In that case, the corresponding input in transient thermal test will remain at the value existing before the import.

5.3.3 Advanced input

There are no advanced inputs required for this test.

5.4 Main principles of computation

5.4.1 Introduction

Here are illustrations which give an overview of the thermal transient test:

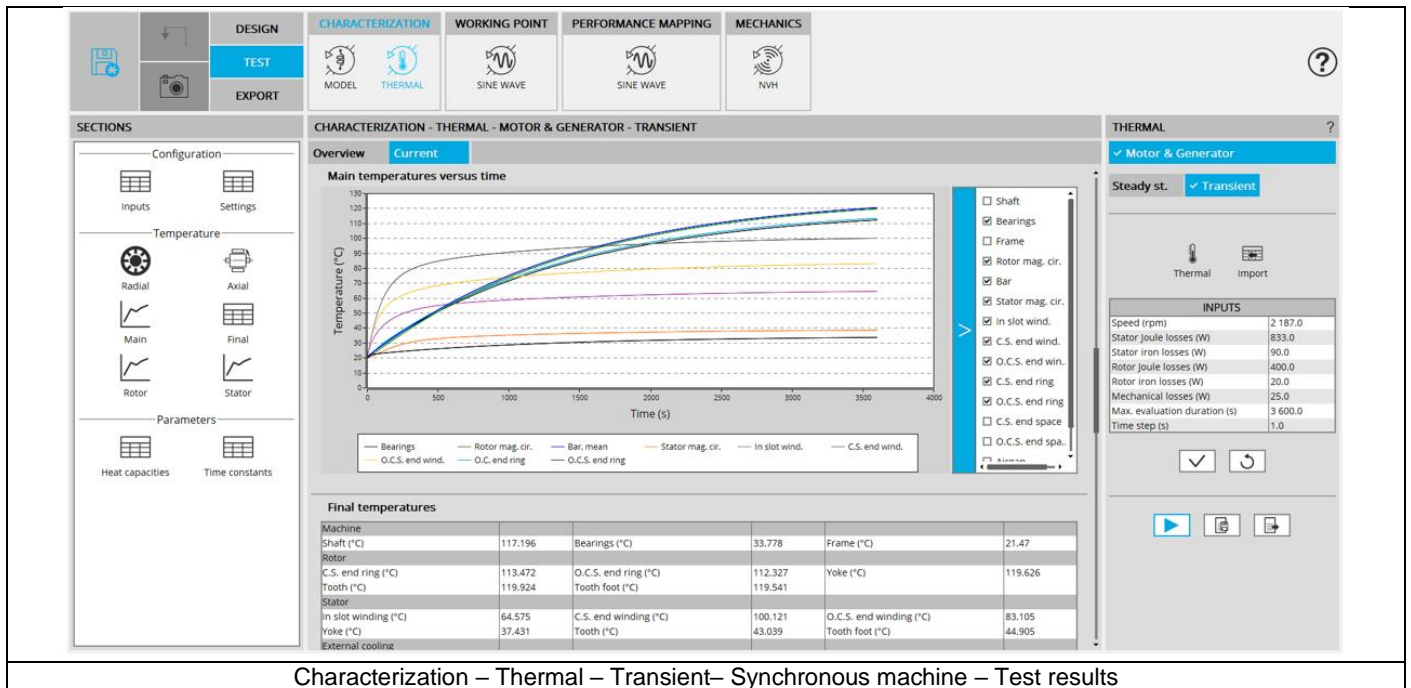
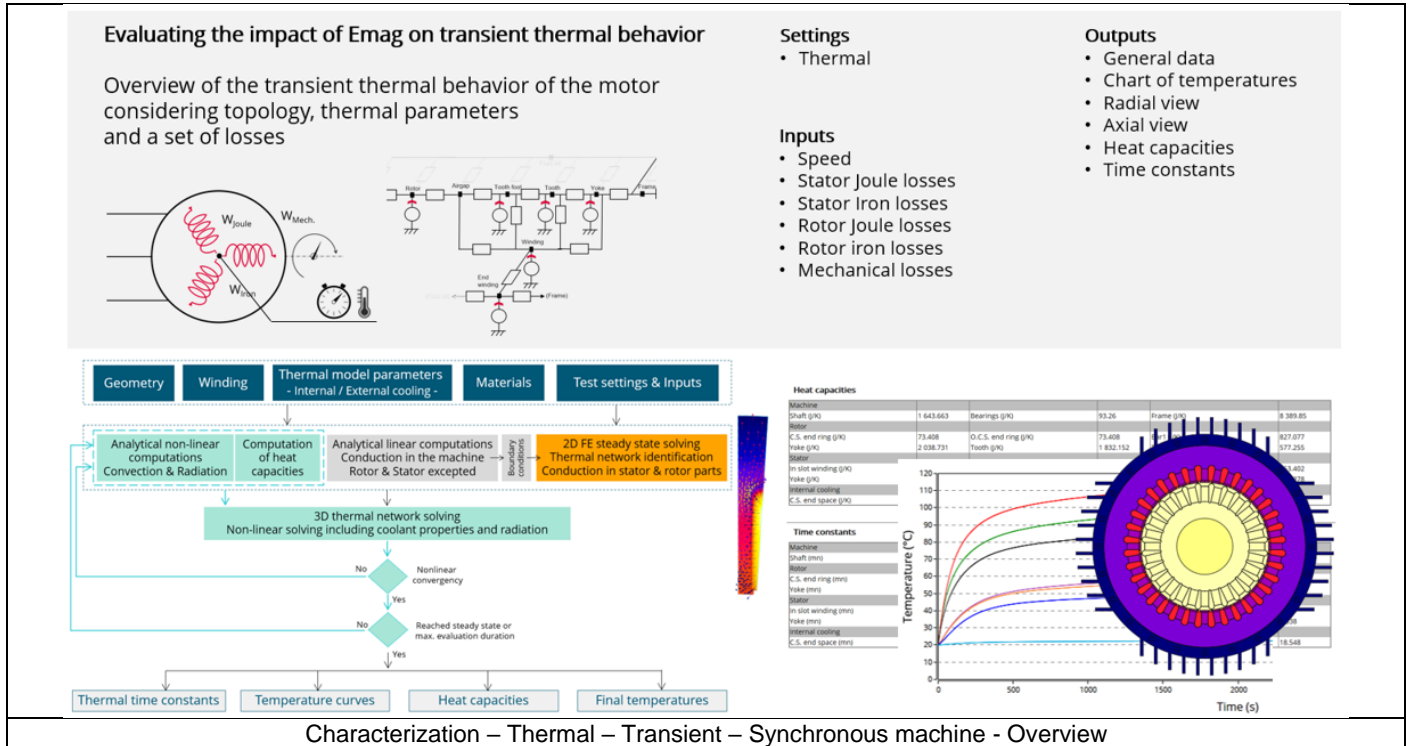

5.4.2 Flow chart

Here is the flowchart illustrating the internal process of the thermal transient test.

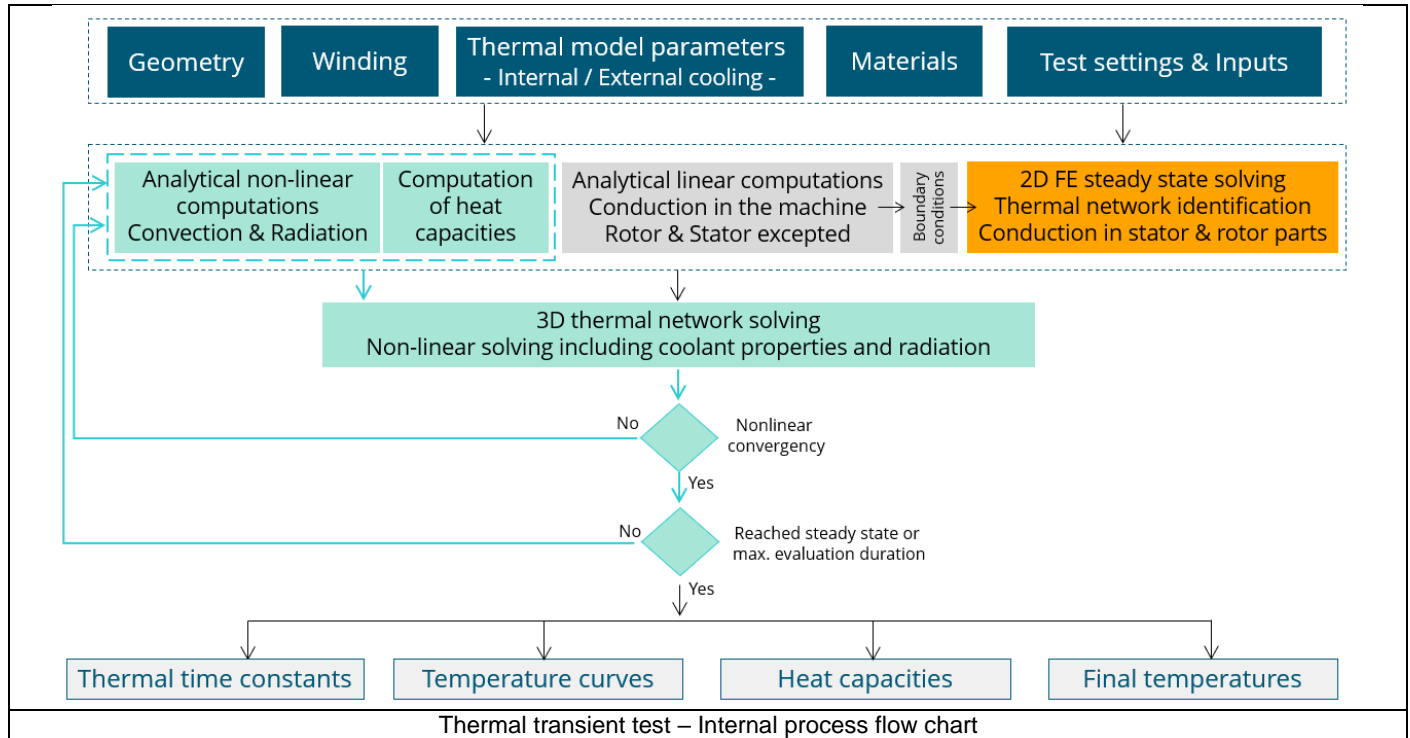

The inputs of the internal process are the parameters of:

- Geometry
- Winding
- Internal cooling
- External cooling
- Materials
- Test settings and inputs

A 2D Finite Element model is solved to identify a thermal network which corresponds accurately to any kind of rotor or stator parts, including user parts.

Then, the resulting network is extended with analytical computations to consider the 3D effect of the geometry at each time step. For that, a non-linear computation is performed in the solving of the transient thermal test.

Each thermal node of the machine is associated to a thermal capacitance, depending of the specific heat and density of the material(s) composing the node, and the associated volume.

Thus, the main provided outputs are the whole chart of temperatures of the machines versus time, the heat capacities, and the time constants.

5.5 Test results

Once a test is finished, the corresponding results are automatically displayed in the central window.

5.5.1 Test conditions

5.5.1.1 Inputs

The speed, the set of losses to be considered in the test in addition to the max evaluation duration and the time step are reminded in the head of results

5.5.1.2 Settings

The thermal settings are reminded:

- External fluid temperature
- Cooling circuit temperature

5.5.2 Main results

- Temperature charts versus time (slider) – radial and axial view
- Main temperatures curve versus time
- Final temperatures table
- Heat capacity table
- Time constant table

5.5.3 Presentation of temperature charts

A slider allows automatically updating the displaying of chart temperature in function of time

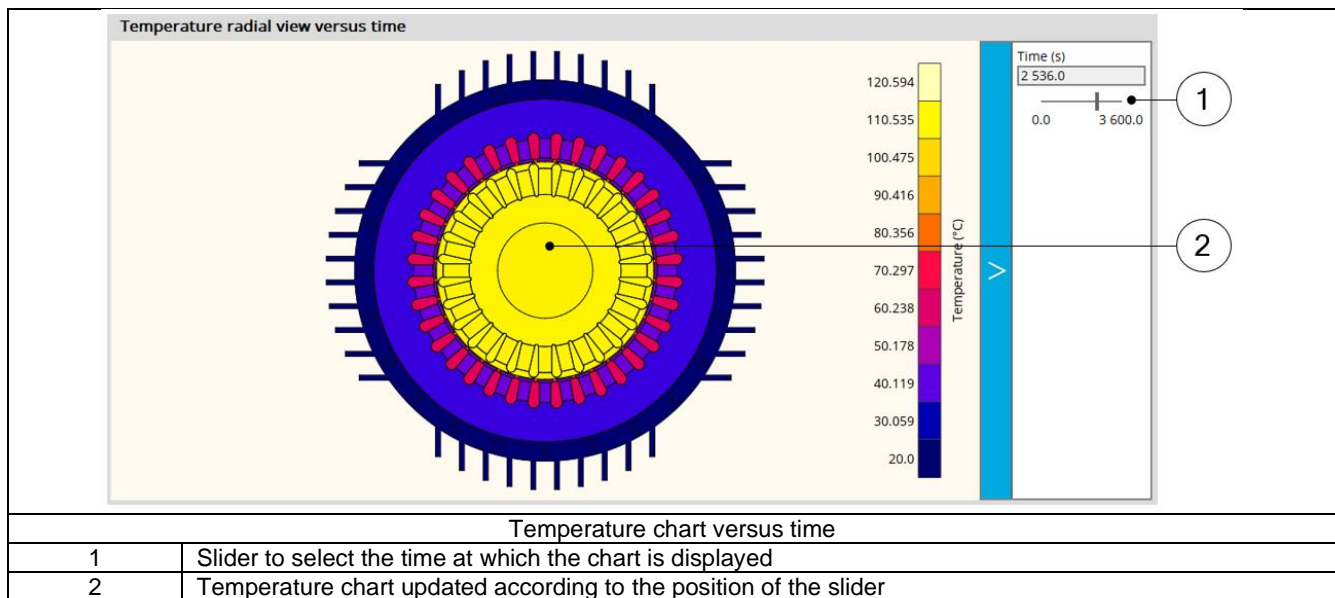

5.6 Limitation of computations - Advice for use

Notes:

- 1) The resistance network identification of a machine is always done without any skew angle. This can bring some inaccuracy in the results for highly skewed machines.
- 2) Please refer to the document: MotorFactory_2023_IMSQ_IOR_3PH_Test_Introduction – section “Limitation of thermal computations – Advice for use”